



WORLDWIDE



**THE STANDARD
IN TIG WELDING**



**MASTER
TIG**

Toll Free: (800) 426.0877
www.CKWORLDWIDE.com

Since 1967, CK Worldwide has brought more innovations to TIG Welding equipment than any other manufacturer. With more patents on product design and improvements than anyone else, CK Worldwide sets THE STANDARD IN TIG WELDING.



CK INNOVATIONS THAT CHANGED AN INDUSTRY:

- Silicone rubber insulation replaces phenolic for better drop protection
- Efficient Gas Saver™ technology reduces operating costs with improved weld quality
- Max-Flo™ water-cooled torches provide up to 4X the cooling capacity—reducing downtime and allowing torches to run longer
- Wedge collet lasts up to 10X longer than standard split collet
- Fail-Safe hose connectors create a positive seal and offer years of dependable service



Our standard line of TIG torches are premium adaptations of the industry classic torches, made by The Linde Group, such as the 9, 17, 18, 20, 24, and 26 styles. These torches are some of the most widely used in the world and come with CK-exclusive features designed over our 50 years in the welding industry.



MasterTIG torches are the highest quality TIG torches available on the market as they include the most cutting-edge designs created by CK Worldwide. These torches were specifically designed to be smaller, lighter, and more compact than our standard line while providing technical advantages that can't be matched.



CONTENTS

TIG WELDING MACHINES

MT375-AC/DC Water-Cooled TIG System.....	4 - 6
WC375 Water Cooler & MT375 Machine Only.....	7
MT200-AC/DC Compact TIG Welding Unit.....	8 - 9

STANDARD TIG TORCHES

Gas Cooled.....	10 - 14
AIRCO TORCHES.....	15
Water Cooled.....	16 - 19

MASTERTIG SERIES TORCHES

MasterTIG Technology & Innovations.....	20
MICRO TORCH.....	21
Gas Cooled.....	22 - 24
Water Cooled.....	25 - 27

ULTRATIG TORCHES

Gas Cooled.....	28
Water Cooled.....	29

GAS SAVER KITS

2 Series, 3 Series, Stubby & Large Diameter.....	30 - 31
--	---------

COLD WIRE FEED

Cold Wire Feed Unit.....	32
Cold Wire Torches Hand Held.....	33
Cold Wire Torches Machine Mounted.....	34
Cold Wire Conduits / Extension Bracket.....	35

MACHINE TORCHES

Robotic Torches.....	36
Barrel Front & Back Loading.....	37

REMOTE AMPERAGE CONTROLS

Steady-Grip™ Trigger & Foot Pedal Control.....	38
Rotary Amperage Control.....	39
Linear Amperage Control.....	40
Wheel Amperage Control.....	41
Electric Switches.....	42

SAFE-LOC HOSE/CABLE CONNECTORS

Dinse.....	43 - 44
Tweco / Cam-Lock.....	45

CABLE ACCESSORIES

Power Cable Adapters.....	46
Cable Extensions.....	47
Cable Extensions / Hose Covers.....	48
CK SCHOLARSHIP & TECH RESOURCES.....	49
PURGE CHAMBER.....	50

CABLES / HOSES

Cable / Hose Types.....	51
Gas Cooled Cables / Hoses <i>All Models</i>	52 - 53
Water Cooled Cables / Hoses <i>All Models</i>	54 - 55
Airco Power Cables / Hoses.....	56
Machine Torch Power Cables / Hoses.....	57

ARGON HOSE / REGULATORS / GAS FLOW TESTER

.....	58
WEDGE COLLET / TORCH HOLDER / E-Z DABR.....	59
PURGE CUPS & TRAILING SHIELDS.....	60

TUNGSTEN

Electrode Grinder Turbo-Sharp® X.....	61
Selection Guide / Stick-Out Gauge.....	62 - 63

TORCH ACCESSORIES & PARTS

Super Cups 2 Series & 3 Series.....	64 - 65
2 Series 9 / 20 & Gas Saver 9 / 20.....	66
3 Series 17 / 18 / 26.....	67
3 Series Gas Saver 17 / 18 / 26.....	68
4 Series Stubby 17 / 18 / 26.....	68
51 Series CK510.....	69
8 Series 24 / 24W.....	69
OZMO & CUT-DOWN 24 / 24W / 80 / 90 / 180.....	69
Micro Torch MR70 / MR140.....	70
Standard Machine Series.....	70
AIRCO A2 Series 10 / 20.....	71
AIRCO A3 Series 16 / 35.....	71
Accessory Kits.....	72 - 73
Flex-Loc Series FL130 / FL150 / FL230 / FL250.....	74
Replacement Torch Heads & Handles.....	75



Need technical information? Call or email to request a copy of our Technical Guide (Form 116)



MT200-AC/DC TIG Welding System
Precision welding in a conveniently packaged system, see pages 8 & 9.

CONNECT WITH US ON:



PHONE: (253) 854.5820 | FAX: (253) 939.1746

TORCHES

MACHINE TORCHES

AMPERAGE CONTROLS

CONNECTORS & CABLES

TUNGSTEN

ACCESSORIES & PARTS

MT375-AC/DC TIG WELDING SYSTEM

POWER, PERFORMANCE & PRODUCTIVITY



The MT375-AC/DC is the answer to both creativity and production driven TIG welding. This innovative water cooled TIG welding system provides the ability to quickly and efficiently adapt to dynamic welding situations, while maintaining the same quality of experience you have come to expect from CK Worldwide.

The MT375AC/DC is a dual voltage powerful 375 amp inverter with; AC balance and frequency, post gas flow settings, and pulse settings that use analog dials allowing for ease of use and range. The MT375 is fully equipped with a dual pump water cooler, utility cart, TL18 Trim-Line 350 amp flex neck torch with Super-Flex cables, ground cable and clamp, argon hose, accessory kit, and new patented Steady-Grip Foot Pedal.

With background testing performed by production welders and the best TIG welding professionals in the industry the MT375 delivers precision welding.



PATENTED STEADY-GRIP FOOT PEDAL AMPERAGE CONTROL

This new foot pedal design provides maximum flexibility due to the integrated Steady-Grip pistol grip amperage control. Simply open up the foot pedal using two quick release bolts and extract the popular Steady-Grip pistol grip amperage control when needed. Attach your torch via the hook-and-loop straps and you're ready to weld!

Steady-Grip™ Foot Pedal is compatible with other welding machines, see page 38 for details.



COMPLETE MT375 WELDING SYSTEM INCLUDES:

- MT375-AC/DC & Utility Cart
- WC375 Dual-pump Water Cooler
- TL18 Flex-Head Torch with 12.5' (3.8m) Super-Flex™ Cables TL18-12SF FX
- Dinse Connector SLWHAT-35
- Gas Saver™ Series 3 Accessories/ Consumables Kit AK-3GS
- Steady-Grip™ Foot Pedal Amperage Control
- Ground Clamp with 12.5' (3.8m) Cable
- Single Flow Regulator
- Nylon Zipper Hose Cover CC-3-10
- 6' (1.8m) Gas Hose ARH-6
- Utility Cart



TL18 FLEX-HEAD TORCH
TL18-12SF FX

350 amp ACHF or DCSP @ 100%
Water-Cooled
Length: 8" (20.3cm)
Weight: 5 oz. (141gm)



Flexible torch neck for precise positioning



SUPER-FLEX CABLES
12.5 feet (3.8m) long

NYLON ZIPPER HOSE COVER
CC-3-10



GROUND CLAMP
12.5 feet (3.8m)



DINSE CONNECTOR SLWHAT-35



GAS HOSE ARH-6
6 feet (1.8m)



GAS-SAVER KIT AK-3GS



SINGLE-FLOW REGULATOR



Foot Pedal Control



Steady-Grip™ pistol grip amperage control option



Insert TL18 or another torch to use (torch shown not included)



Remove handle to use as linear slide configuration (torch shown not included)

MT375-AC/DC TIG WELDING SYSTEM

INCLUDES: MT375-AC/DC TIG Welding Machine, Water Cooler, Torch, Cables, Cart & Accessories



CONTROLS

Advanced technology with an easy-to-use interface, perfect for all welders, from the novice to the master craftsman

MT375 SPECIFICATIONS

Input Voltage	230VAC ±10%, 50/60Hz, single phase
	460VAC ±10%, 50/60Hz, single phase
Input Current (I max)(I eff)	230V: 44 Amps / 26 Amps
	460V: 38 Amps / 23 Amps
Output Current Range GTAW	230V: 5 - 275 Amps DC; 5 - 260 Amps AC
	460V: 5 - 375 Amps DC; 5 - 360 Amps AC
Output Current Range SMAW	230V: 10 - 200 Amps DC
	460V: 10 - 300 Amps DC
Rated Output GTAW	230V: 275 Amps @ 21.0 VDC, 35% duty cycle 260 Amps @ 20.4 VAC, 35% duty cycle
	460V: 375 Amps @ 25.0 VDC, 35% duty cycle 360 Amps @ 24.2 VAC, 35% duty cycle
Rated Output SMAW	230V: 200 Amps @ 28.0 VDC, 40% duty cycle
	460V: 300 Amps @ 32.0 VDC, 40% duty cycle
Max. Open Circuit Volts	84 volts

Gas Pre-flow	0.5 seconds
Gas Post-flow	0.5 - 20 seconds
AC Frequency	20 - 200 Hz
Pulse Frequency	1 - 200 Hz
Pulse Width	50%
Background Current	10 - 100%
Arc Start	High Frequency
MT375 Dimensions	Height: 15 in. (381mm)
	Width: 10.5 in. (267mm)
	Length: 20.5 in. (521mm)
MT375 Weight	82 lb. (37.2kg)
Full System Dimensions	Height: 45 in. (1143mm)
	Width: 20 in. (508mm)
	Length: 42 in. (1067mm)
System Weight	170 lb. (77.1kg)

PLEASE NOTE WHEN USING GENERATOR POWER:
MINIMUM SUGGESTED POWER IS 15KVA @ 230 Volts



DUAL-PUMP WATER COOLER

The WC375 water cooler included with the MT375 TIG welding system may also be purchased separately. The WC375 delivers maximum coolant flow due to the unit's twin pumps. Dual pumps work in tandem, one to pull coolant from system and one to push coolant into system maintaining proper volume of coolant. Twin fans insure maximum cooling on extra-large heat exchangers.

KEY FEATURES:

- Corrosion free
- No priming required
- Quick fill and drain, no-spill tank
- Easy maintenance



WC375 SPECIFICATIONS

Input Voltage	110VAC ±10%, 50/60Hz
Input Current (I max)	5 Amps
BTU (max)	14,200
Coolant Capacity	9 liters / 2.5 gallons
Coolant Type	Binzel® BTC-15 is recommended. 80% distilled water/20% organic coolant.
Unit Dimensions	Height: 18 in. (457mm)
	Width: 10.5 in. (267mm)
	Length: 24 in. (610mm)

Order # **WC375**

MT375-AC/DC MACHINE ONLY

The MT375AC/DC is a dual voltage powerful 375 amp inverter with; AC balance and frequency, post gas flow settings, and pulse settings that use analog dials allowing for ease of use and range.

Order # **MT375-AC/DC-MO**



MT200-AC/DC TIG WELDING SYSTEM

CREATE, REPAIR & CUSTOMIZE



The MT200-AC/DC is the answer to both creativity and production driven TIG welding. This innovative TIG welding machine provides the ability to quickly and efficiently adapt to dynamic welding situations, while maintaining the same quality of experience you have come to expect from CK Worldwide.

Its compact portable design allows you to easily tackle any project from fabrication and education to aerospace and nuclear applications. Whether you TIG weld for enjoyment or as a career you will find that the MT200 can help you accomplish your toughest welding challenges.

With background testing performed by production welders and the best TIG welding professionals in the industry the MT200 delivers precision welding in a conveniently packaged system.

COMPLETE WELDING SYSTEM INCLUDES:

- MT200-AC/DC
- CK17 Flex-Head Torch with 12.5' (3.8m) Super-Flex™ Cables CK17-12-RSF FX
- Dinse Connector SL2-35MT
- AK-3 Accessories/Consumables Kit AK-3
- Steady-Grip™ Foot Pedal Amperage Control
- Ground Clamp with 12.5' (3.8m) Cable
- Single Flow Regulator
- 6' (1.8m) Gas Hose ARH-6
- 220V to 115V Power Adapter



CK17 FLEX-HEAD TORCH
CK-17-12-RSF FX

150 amp ACHF or DCSP @ 100%
Gas-Cooled
Length: 8-3/4" (22.2cm)
Weight: 5 oz. (141gm)



Flexible torch neck for precise positioning



POWER ADAPTER



SUPER-FLEX™ POWER CABLES
12.5 feet (3.8m) long

DINSE CONNECTOR SL2-35MT

STEADY-GRIP FOOT PEDAL AMPERAGE CONTROL



ACCESSORIES / CONSUMABLES AK-3



3 Cups

3 Collets

3 Collet Bodies

1 Short Backcap

3 Tungsten Electrodes

1 Long Backcap

GROUND CLAMP
12.5 feet
(3.8m)



SINGLE-FLOW REGULATOR

GAS HOSE ARH-6
6 feet
(1.8m)





"As a welder of critical aircraft hardware, this machine is extremely easy to use and runs as smooth as our more expensive machines at work!"

- R. Harper, AIRCRAFT WELDER, 38 YEARS EXPERIENCE



Order # **MT200-AC/DC**

CONTROLS

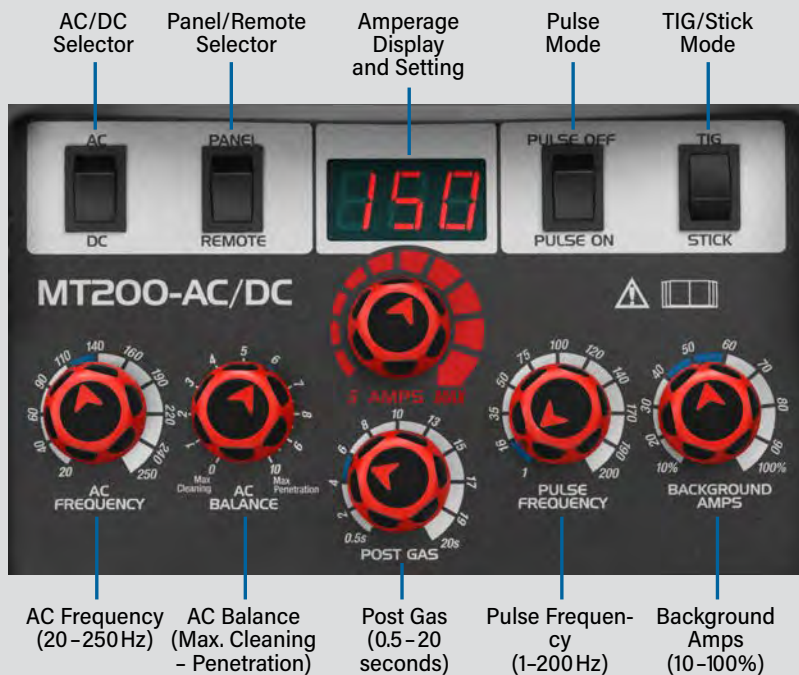

Advanced technology with an easy-to-use interface, perfect for all welders, from the novice to the master craftsman

MT200 SPECIFICATIONS

Input Voltage	115VAC ±15%, 50/60Hz 220VAC ±15%, 50/60Hz, single phase
Input Current (I max)	115V: 21 Amps 220V: 34 Amps
Output Current Range GTAW	115V: 5 - 140 Amps 220V: 5 - 200 Amps
Output Current Range SMAW	115V: 10 - 110 Amps 220V: 10 - 160 Amps
Rated Output GTAW	115V: 140A @ 15.6V, 40% duty cycle 220V: 200A @ 18.0V, 25% duty cycle
Rated Output SMAW	115V: 110A @ 24.4V, 25% duty cycle 220V: 160A @ 26.4V, 30% duty cycle
Max. Open Circuit Volts	74 volts
Gas Pre-flow	0.5 seconds
Gas Post-flow	0.5 - 20 seconds
AC Frequency	20 - 250 Hz
Pulse Frequency	1 - 200 Hz
Pulse Width	50%
Base Current	10 - 100%
Arc Start	High Frequency
Dimensions	Height: 15 in. (381mm) Width: 8.5 in. (217mm) Length: 20 in. (502mm)
Weight	32 lb. (14.5 kg)

CK24



GAS COOLED | SAME AS CK80 & CK90

80 amp/90 amp ACHF or DCSP @ 100%

8 Series Head Accessories

CK24 & CK24V | RIGID | 80 AMP

HEAD STYLE	CABLE	CABLE LENGTH	STANDARD #	SUPER-FLEX #	SPECIFICATIONS
RIGID	1 Piece	12.5 ft. (3.8m)	CK24-12-R RG	CK24-12-RSF RG	8-1/4" (20.9cm)
		25 ft. (7.6m)	CK24-25-R RG	CK24-25-RSF RG	
	2 Piece	12.5 ft. (3.8m)	CK24-12-2 RG	CK24-12-2SF RG	2-1/4 oz (64gm)
		25 ft. (7.6m)	CK24-25-2 RG	CK24-25-2SF RG	
RIGID + VALVE	1 Piece	12.5 ft. (3.8m)	CK24V-12-R RG	CK24V-12-RSF RG	2-1/4 oz (64gm)
		25 ft. (7.6m)	CK24V-25-R RG	CK24V-25-RSF RG	
	2 Piece	12.5 ft. (3.8m)	CK24V-12-2 RG	CK24V-12-2SF RG	2-1/4 oz (64gm)
		25 ft. (7.6m)	CK24V-25-2 RG	CK24V-25-2SF RG	

PARTS CONSUMABLES 69 / TORCH 75 / HANDLE 75 / CABLES 52 / ADAPTER/DINSE 43-44 & 46



CK24 CK80

CK24 & CK24V | FLEX | 90 AMP

HEAD STYLE	CABLE	CABLE LENGTH	STANDARD #	SUPER-FLEX #	SPECIFICATIONS
FLEX	1 Piece	12.5 ft. (3.8m)	CK24-12-R FX	CK24-12-RSF FX	8-1/4" (20.9cm)
		25 ft. (7.6m)	CK24-25-R FX	CK24-25-RSF FX	
	2 Piece	12.5 ft. (3.8m)	CK24-12-2 FX	CK24-12-2SF FX	2-1/4 oz (64gm)
		25 ft. (7.6m)	CK24-25-2 FX	CK24-25-2SF FX	
FLEX + VALVE	1 Piece	12.5 ft. (3.8m)	CK24V-12-R FX	CK24V-12-RSF FX	2-1/4 oz (64gm)
		25 ft. (7.6m)	CK24V-25-R FX	CK24V-25-RSF FX	
	2 Piece	12.5 ft. (3.8m)	CK24V-12-2 FX	CK24V-12-2SF FX	2-1/4 oz (64gm)
		25 ft. (7.6m)	CK24V-25-2 FX	CK24V-25-2SF FX	

PARTS CONSUMABLES 69 / TORCH 75 / HANDLE 75 / CABLES 52 / ADAPTER/DINSE 43-44 & 46



CK24 FLEX CK90

LOW PROFILE TORCH & KIT PACKAGES

80AMP OZMO

HEAD STYLE	CABLE	CABLE LENGTH	SUPER-FLEX #
RIGID	1 Piece SUPER-FLEX	12.5 ft. (3.8m)	CK24-12SF-OZMO
		25 ft. (7.6m)	CK24-25SF-OZMO

PARTS TORCH BODY CK24 / HANDLE HS / CABLES 52

OZMO

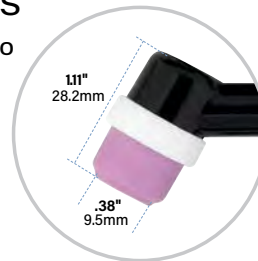

ACCESSORY KIT ONLY KIT-OZMO

80AMP CUT-DOWN

HEAD STYLE	CABLE	CABLE LENGTH	SUPER-FLEX #
RIGID	1 Piece SUPER-FLEX	12.5 ft. (3.8m)	CK24-12SF-CD
		25 ft. (7.6m)	CK24-25SF-CD

PARTS TORCH BODY CK24 / HANDLE HS / CABLES 52

CUT-DOWN

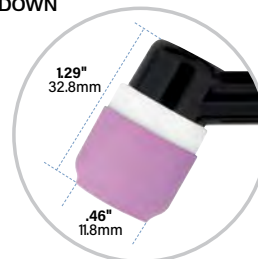

ACCESSORY KIT ONLY KIT-CD



8 Series, OZMO, and Cut-Down Accessory Kits available on page 73 for these torches.



CK9

GAS COOLED
125 amp ACHF or DCSP @ 100%
2 Series Head Accessories

125
AMP

GAS COOLED

CK9 & CK9V | RIGID

HEAD STYLE	CABLE	CABLE LENGTH	STANDARD #	SUPER-FLEX #	SPECIFICATIONS
RIGID	1 Piece	12.5 ft. (3.8m)	CK9-12-R RG	CK9-12-RSF RG	7-1/2" (19.0cm)
		25 ft. (7.6m)	CK9-25-R RG	CK9-25-RSF RG	
	2 Piece	12.5 ft. (3.8m)	CK9-12-2 RG	CK9-12-2SF RG	2.75 oz (78gm)
		25 ft. (7.6m)	CK9-25-2 RG	CK9-25-2SF RG	
RIGID + VALVE	1 Piece	12.5 ft. (3.8m)	CK9V-12-R RG	CK9V-12-RSF RG	
		25 ft. (7.6m)	CK9V-25-R RG	CK9V-25-RSF RG	
	2 Piece	12.5 ft. (3.8m)	CK9V-12-2 RG	CK9V-12-2SF RG	
		25 ft. (7.6m)	CK9V-25-2 RG	CK9V-25-2SF RG	

PARTS CONSUMABLES 66 / TORCH 75 / HANDLE 75 / CABLES 52 / ADAPTER/DINSE 43-44 & 46

CK9 & CK9V | FLEX

HEAD STYLE	CABLE	CABLE LENGTH	STANDARD #	SUPER-FLEX #	SPECIFICATIONS
FLEX	1 Piece	12.5 ft. (3.8m)	CK9-12-R FX	CK9-12-RSF FX	8" (20.3cm)
		25 ft. (7.6m)	CK9-25-R FX	CK9-25-RSF FX	
	2 Piece	12.5 ft. (3.8m)	CK9-12-2 FX	CK9-12-2SF FX	3.5 oz (99gm)
		25 ft. (7.6m)	CK9-25-2 FX	CK9-25-2SF FX	
FLEX + VALVE	1 Piece	12.5 ft. (3.8m)	CK9V-12-R FX	CK9V-12-RSF FX	
		25 ft. (7.6m)	CK9V-25-R FX	CK9V-25-RSF FX	
	2 Piece	12.5 ft. (3.8m)	CK9V-12-2 FX	CK9V-12-2SF FX	
		25 ft. (7.6m)	CK9V-25-2 FX	CK9V-25-2SF FX	

PARTS CONSUMABLES 66 / TORCH 75 / HANDLE 75 / CABLES 52 / ADAPTER/DINSE 43-44 & 46

CK9P & CK9PV | PENCIL

HEAD STYLE	CABLE	CABLE LENGTH	STANDARD #	SUPER-FLEX #	SPECIFICATIONS
RIGID	1 Piece	12.5 ft. (3.8m)	CK9P-12-R	CK9P-12-RSF	7-3/4" (19.7cm)
		25 ft. (7.6m)	CK9P-25-R	CK9P-25-RSF	
	2 Piece	12.5 ft. (3.8m)	CK9P-12-2	CK9P-12-2SF	3 oz (85gm)
		25 ft. (7.6m)	CK9P-25-2	CK9P-25-2SF	
RIGID + VALVE	1 Piece	12.5 ft. (3.8m)	CK9PV-12-R	CK9PV-12-RSF	
		25 ft. (7.6m)	CK9PV-25-R	CK9PV-25-RSF	
	2 Piece	12.5 ft. (3.8m)	CK9PV-12-2	CK9PV-12-2SF	
		25 ft. (7.6m)	CK9PV-25-2	CK9PV-25-2SF	

PARTS CONSUMABLES 66 / TORCH 75 / HANDLE 75 / CABLES 52 / ADAPTER/DINSE 43-44 & 46

CKPF130 | PENCIL FLEX 10" (25.4cm) length available, call for ordering information.

HEAD STYLE	CABLE	CABLE LENGTH	STANDARD #	SUPER-FLEX #	SPECIFICATIONS
FLEX	1 Piece	12.5 ft. (3.8m)	CKPF1312H	CKPF1312HSF	11" (27.9cm)
		25 ft. (7.6m)	CKPF1325H	CKPF1325HSF	3 oz (85gm)

PARTS CONSUMABLES 66 / TORCH 75 / HANDLE 75 / CABLES 52 / ADAPTER/DINSE 43-44 & 46



2 Series Accessory Kits available on pages 72 & 73 for these torches.

PHONE: (253) 854.5820 | FAX: (253) 939.1746

CK17

GAS COOLED | SAME AS CK150
 150 amp ACHF or DCSP @ 100%
 3 Series Head Accessories



CK17 & CK17V | RIGID

HEAD STYLE	CABLE	CABLE LENGTH	STANDARD #	SUPER-FLEX #	SPECIFICATIONS
RIGID	1 Piece	12.5 ft. (3.8m)	CK17-12-R RG	CK17-12-RSF RG	8-1/8" (20.6cm)
		25 ft. (7.6m)	CK17-25-R RG	CK17-25-RSF RG	
	2 Piece	12.5 ft. (3.8m)	CK17-12-2 RG	CK17-12-2SF RG	5 oz (141gm)
		25 ft. (7.6m)	CK17-25-2 RG	CK17-25-2SF RG	
RIGID + VALVE	1 Piece	12.5 ft. (3.8m)	CK17V-12-R RG	CK17V-12-RSF RG	5 oz (141gm)
		25 ft. (7.6m)	CK17V-25-R RG	CK17V-25-RSF RG	
	2 Piece	12.5 ft. (3.8m)	CK17V-12-2 RG	CK17V-12-2SF RG	5 oz (141gm)
		25 ft. (7.6m)	CK17V-25-2 RG	CK17V-25-2SF RG	

PARTS CONSUMABLES 67-68 / TORCH 75 / HANDLE 75 / CABLES 52 / ADAPTER/DINSE 43-44 & 46



CK17 & CK17V | FLEX

HEAD STYLE	CABLE	CABLE LENGTH	STANDARD #	SUPER-FLEX #	SPECIFICATIONS
FLEX	1 Piece	12.5 ft. (3.8m)	CK17-12-R FX	CK17-12-RSF FX	8-3/4" (22.2cm)
		25 ft. (7.6m)	CK17-25-R FX	CK17-25-RSF FX	
	2 Piece	12.5 ft. (3.8m)	CK17-12-2 FX	CK17-12-2SF FX	5 oz (141gm)
		25 ft. (7.6m)	CK17-25-2 FX	CK17-25-2SF FX	
FLEX + VALVE	1 Piece	12.5 ft. (3.8m)	CK17V-12-R FX	CK17V-12-RSF FX	5 oz (141gm)
		25 ft. (7.6m)	CK17V-25-R FX	CK17V-25-RSF FX	
	2 Piece	12.5 ft. (3.8m)	CK17V-12-2 FX	CK17V-12-2SF FX	5 oz (141gm)
		25 ft. (7.6m)	CK17V-25-2 FX	CK17V-25-2SF FX	

PARTS CONSUMABLES 67-68 / TORCH 75 / HANDLE 75 / CABLES 52 / ADAPTER/DINSE 43-44 & 46



CK17RG-T & CK17VRG-T | THREAD-ON

HEAD STYLE	CABLE	CABLE LENGTH	STANDARD #	SUPER-FLEX #	SPECIFICATIONS
RIGID	1 Piece	12.5 ft. (3.8m)	CK17-12-R RG-T	CK17-12-RSFRG-T	8-1/8" (20.6cm)
		25 ft. (7.6m)	CK17-25-R RG-T	CK17-25-RSFRG-T	
	2 Piece	12.5 ft. (3.8m)	CK17-12-2 RG-T	CK17-12-2SFRG-T	5 oz (141gm)
		25 ft. (7.6m)	CK17-25-2 RG-T	CK17-25-2SFRG-T	
RIGID + VALVE	1 Piece	12.5 ft. (3.8m)	CK17V-12-R RG-T	CK17V-12-RSFRGT	5 oz (141gm)
		25 ft. (7.6m)	CK17V-25-R RG-T	CK17V-25-RSFRGT	
	2 Piece	12.5 ft. (3.8m)	CK17V-12-2 RG-T	CK17V-12-2SFRGT	5 oz (141gm)
		25 ft. (7.6m)	CK17V-25-2 RG-T	CK17V-25-2SFRGT	

PARTS CONSUMABLES 67-68 / TORCH 75 / HANDLE 75 / CABLES 52 / ADAPTER/DINSE 43-44 & 46



Threaded handle

CK17P | PENCIL

HEAD STYLE	CABLE	CABLE LENGTH	STANDARD #	SUPER-FLEX #	SPECIFICATIONS
RIGID	1 Piece	12.5 ft. (3.8m)	CK17P-12-R RG	CK17P-12-RSF	8-1/2" (21.6cm)
		25 ft. (7.6m)	CK17P-25-R RG	CK17P-25-RSF	
	2 Piece	12.5 ft. (3.8m)	CK17P-12-2	CK17P-12-2SF	3 oz (85gm)
		25 ft. (7.6m)	CK17P-25-2	CK17P-25-2SF	

PARTS CONSUMABLES 67-68 / TORCH 75 / HANDLE 75 / CABLES 52 / ADAPTER/DINSE 43-44 & 46





CK26

GAS COOLED
200 amp ACHF or DCSP @ 100%
3 Series Head Accessories

200
AMP

GAS COOLED

CK26 & CK26V | RIGID

HEAD STYLE	CABLE	CABLE LENGTH	STANDARD #	SUPER-FLEX #	SPECIFICATIONS
RIGID	1 Piece	12.5 ft. (3.8m)	CK26-12-R RG	CK26-12-RSF RG	9-1/2" (24.1cm)
		25 ft. (7.6m)	CK26-25-R RG	CK26-25-RSF RG	
	2 Piece	12.5 ft. (3.8m)	CK26-12-2 RG	CK26-12-2SF RG	7-1/2 oz (212gm)
		25 ft. (7.6m)	CK26-25-2 RG	CK26-25-2SF RG	
RIGID + VALVE	1 Piece	12.5 ft. (3.8m)	CK26V-12-R RG	CK26V-12-RSF RG	7/8" x 14RH power cable connections
		25 ft. (7.6m)	CK26V-25-R RG	CK26V-25-RSF RG	
	2 Piece	12.5 ft. (3.8m)	CK26V-12-2 RG	CK26V-12-2SF RG	
		25 ft. (7.6m)	CK26V-25-2 RG	CK26V-25-2SF RG	

PARTS CONSUMABLES 67-68 / TORCH 75 / HANDLE 75 / CABLES 52 / ADAPTER/DINSE 43-44 & 46



CK26 & CK26V | FLEX

HEAD STYLE	CABLE	CABLE LENGTH	STANDARD #	SUPER-FLEX #	SPECIFICATIONS
FLEX	1 Piece	12.5 ft. (3.8m)	CK26-12-R FX	CK26-12-RSF FX	9-5/8" (24.4cm)
		25 ft. (7.6m)	CK26-25-R FX	CK26-25-RSF FX	
	2 Piece	12.5 ft. (3.8m)	CK26-12-2 FX	CK26-12-2SF FX	7-1/2 oz (212gm)
		25 ft. (7.6m)	CK26-25-2 FX	CK26-25-2SF FX	
FLEX + VALVE	1 Piece	12.5 ft. (3.8m)	CK26V-12-R FX	CK26V-12-RSF FX	7/8" x 14RH power cable connections
		25 ft. (7.6m)	CK26V-25-R FX	CK26V-25-RSF FX	
	2 Piece	12.5 ft. (3.8m)	CK26V-12-2 FX	CK26V-12-2SF FX	
		25 ft. (7.6m)	CK26V-25-2 FX	CK26V-25-2SF FX	

PARTS CONSUMABLES 67-68 / TORCH 75 / HANDLE 75 / CABLES 52 / ADAPTER/DINSE 43-44 & 46



CK26P | PENCIL

HEAD STYLE	CABLE	CABLE LENGTH	STANDARD #	SUPER-FLEX #	SPECIFICATIONS
RIGID	1 Piece	12.5 ft. (3.8m)	CK26P-12-R	CK26P-12-RSF	9-1/4" (23.5cm)
		25 ft. (7.6m)	CK26P-25-R	CK26P-25-RSF	
	2 Piece	12.5 ft. (3.8m)	CK26P-12-2	CK26P-12-2SF	3 oz (85gm)
		25 ft. (7.6m)	CK26P-25-2	CK26P-25-2SF	

PARTS CONSUMABLES 67-68 / TORCH 75 / HANDLE 75 / CABLES 52 / ADAPTER/DINSE 43-44 & 46



3 Series Accessory Kits
available on pages 72 & 73
for these torches.

CK26HD

GAS COOLED | HEAVY DUTY
 300 amp ACHF or DCSP @ 60%
 3 Series Head Accessories

Designed for heavy duty applications where water-cooled torches aren't an option. The CK26 Heavy Duty torch packages allow for higher amperage capabilities by utilizing a larger gauge power cable and separate SuperFlex™ gas/argon line.



Standard Lug Connector

CK26HD | RIGID STANDARD LUG CONNECTOR

HEAD STYLE	CABLE	CABLE LENGTH	STANDARD #	SPECIFICATIONS
RIGID	2 Piece	12.5 ft. (3.8m)	CKCS26122RG	9-1/2" (24.1cm) 7-1/2 oz (212gm)
		25 ft. (7.6m)	CKCS26252RG	
RIGID + VALVE	2 Piece	12.5 ft. (3.8m)	CKCS26V122RG	9-1/2" (24.1cm) 7-1/2 oz (212gm)
		25 ft. (7.6m)	CKCS26V252RG	

PARTS CONSUMABLES 67-68 / TORCH 75 / HANDLE 75 / CABLES 53

CK26HD | FLEX STANDARD LUG CONNECTOR

HEAD STYLE	CABLE	CABLE LENGTH	STANDARD #	SPECIFICATIONS
FLEX	2 Piece	12.5 ft. (3.8m)	CKCS26122FX	9-5/8" (24.4cm) 7-1/2 oz (212gm)
		25 ft. (7.6m)	CKCS26252FX	
FLEX + VALVE	2 Piece	12.5 ft. (3.8m)	CKCS26V122FX	9-5/8" (24.4cm) 7-1/2 oz (212gm)
		25 ft. (7.6m)	CKCS26V252FX	

PARTS CONSUMABLES 67-68 / TORCH 75 / HANDLE 75 / CABLES 53

CK26HD | RIGID & FLEX TWECO CONNECTOR

HEAD STYLE	CABLE	CABLE LENGTH	STANDARD #	SPECIFICATIONS
RIGID + VALVE	2 Piece	12.5 ft. (3.8m)	CKCS26V122RGGI	9-1/2" (24.1cm) 7-1/2 oz (212gm)
		25 ft. (7.6m)	CKCS26V252RGGI	
FLEX + VALVE	2 Piece	12.5 ft. (3.8m)	CKCS26V122FXGI	9-1/2" (24.1cm) 7-1/2 oz (212gm)
		25 ft. (7.6m)	CKCS26V252FXGI	

PARTS CONSUMABLES 67-68 / TORCH 75 / HANDLE 75 / CABLES 53

CK26HD uses same torch body as CK26.



Tweco Connector
 2MPC-Male



AIRCO TORCHES

Super-Flex™ cables available upon request, contact customer service for details.

CKA10 & CKA10V | AIRCO 100 AMP

HEAD STYLE	CABLE	CABLE LENGTH	STANDARD #	SPECIFICATIONS
RIGID	1 Piece*	12.5 ft. (3.8m)	CKA102	8-1/8" (20.6cm) 3-1/2 oz (99gm) A2 Series Head Accessories
		25 ft. (7.6m)	CKA105	
RIGID + VALVE	1 Piece*	12.5 ft. (3.8m)	CKA102V	A2 Series Head Accessories
		25 ft. (7.6m)	CKA105V	
PARTS CONSUMABLES 71 / TORCH 75 / HANDLE 75 / CABLES 56 / ADAPTER 46				

CKA16 & CKA16V | AIRCO 200 AMP

HEAD STYLE	CABLE	CABLE LENGTH	STANDARD #	SPECIFICATIONS
RIGID	1 Piece*	12.5 ft. (3.8m)	CKA162 RG	9-3/8" (23.8cm) 7-1/2 oz (212gm) A3 Series Head Accessories
		25 ft. (7.6m)	CKA165 RG	
	2 Piece*	12.5 ft. (3.8m)	CKA162N RG	
		25 ft. (7.6m)	CKA165N RG	
RIGID + VALVE	1 Piece*	12.5 ft. (3.8m)	CKA162V RG	A3 Series Head Accessories
		25 ft. (7.6m)	CKA165V RG	
	2 Piece*	12.5 ft. (3.8m)	CKA162VN RG	
		25 ft. (7.6m)	CKA165VN RG	
PARTS CONSUMABLES 71 / TORCH 75 / HANDLE 75 / CABLES 56 / ADAPTER/DINSE 43-44 & 46				

CKA16 & CKA16V FLEX | AIRCO 200 AMP

HEAD STYLE	CABLE	CABLE LENGTH	STANDARD #	SPECIFICATIONS
FLEX	1 Piece*	12.5 ft. (3.8m)	CKA162 FX	9-3/8" (23.8cm) 7-1/2 oz (212gm) A3 Series Head Accessories
		25 ft. (7.6m)	CKA165 FX	
	2 Piece*	12.5 ft. (3.8m)	CKA162N FX	
		25 ft. (7.6m)	CKA165N FX	
FLEX + VALVE	1 Piece*	12.5 ft. (3.8m)	CKA162V FX	A3 Series Head Accessories
		25 ft. (7.6m)	CKA165V FX	
	2 Piece*	12.5 ft. (3.8m)	CKA162VN FX	
		25 ft. (7.6m)	CKA165VN FX	
PARTS CONSUMABLES 71 / TORCH 75 / HANDLE 75 / CABLES 56 / ADAPTER/DINSE 43-44 & 46				

CKA20 & CKA20V | AIRCO 250 AMP

HEAD STYLE	CABLE	CABLE LENGTH	TRI-FLEX #	SPECIFICATIONS
RIGID	3 Piece*	12.5 ft. (3.8m)	CKA202	8-1/2" (21.6cm) 4 oz (113gm) A2 Series Head Accessories
		25 ft. (7.6m)	CKA205	
RIGID + VALVE	3 Piece*	12.5 ft. (3.8m)	CKA202V	A2 Series Head Accessories
		25 ft. (7.6m)	CKA205V	
PARTS CONSUMABLES 71 / TORCH 75 / HANDLE 75 / CABLES 56 / ADAPTER 46				

CKA35 & CKA35V | AIRCO 350 AMP

HEAD STYLE	CABLE	CABLE LENGTH	TRI-FLEX #	SPECIFICATIONS
RIGID	3 Piece*	12.5 ft. (3.8m)	CKA352	8-1/2" (21.6cm) 4 oz (113gm) A3 Series Head Accessories
		25 ft. (7.6m)	CKA355	
RIGID + VALVE	3 Piece*	12.5 ft. (3.8m)	CKA352V	A3 Series Head Accessories
		25 ft. (7.6m)	CKA355V	
PARTS CONSUMABLES 71 / TORCH 75 / HANDLE 75 / CABLES 56 / ADAPTER 46				



CK24W

WATER COOLED

180 amp ACHF or DCSP @ 100%

8 Series Head Accessories



CK24W | RIGID

HEAD STYLE	CABLE	CABLE LENGTH	STANDARD #	TRI-FLEX #	SUPER-FLEX #	SPECIFICATIONS
RIGID	3 Piece	12.5 ft. (3.8m)	CK24W-12	CK1812	CK24W-12SF	8-1/8" (20.6cm)
		25 ft. (7.6m)	CK24W-25	CK1825	CK24W-25SF	3-1/2 oz (99gm)

PARTS CONSUMABLES 69 / TORCH 75 / HANDLE 75 / CABLES 54 / ADAPTER/DINSE 43-44 & 46

CK24W | RIGID EXTRA LENGTH SERIES

HEAD STYLE	CABLE	CABLE LENGTH	TRI-FLEX #	SUPER-FLEX #
LONG HEAD 4-1/2" Neck	3 Piece	12.5 ft. (3.8m)	CKL1812	CKL1812SF
		25 ft. (7.6m)	CKL1825	CKL1825SF
X-LONG HEAD 7-1/2" Neck	3 Piece	12.5 ft. (3.8m)	CKXL1812	CKXL1812SF
		25 ft. (7.6m)	CKXL1825	CKXL1825SF
XX-LONG HEAD 11-1/2" Neck	3 Piece	12.5 ft. (3.8m)	CKXXL1812	CKXXL1812SF
		25 ft. (7.6m)	CKXXL1825	CKXXL1825SF

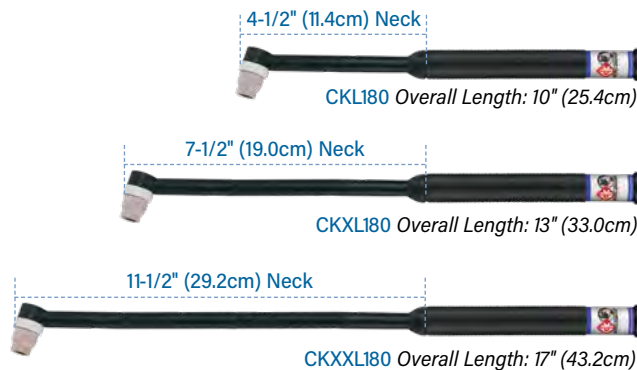

PARTS CONSUMABLES 69 / TORCH 75 / HANDLE 75 / CABLES 54 / ADAPTER/DINSE 43-44 & 46

LOW PROFILE TORCH & KIT PACKAGES

180AMP OZMO

HEAD STYLE	CABLE	CABLE LENGTH	SUPER-FLEX #
RIGID	3 Piece	12.5 ft. (3.8m)	CK24W-12SF-OZMO
		25 ft. (7.6m)	CK24W-25SF-OZMO

PARTS TORCH BODY CK24W / HANDLE HS / CABLES 55

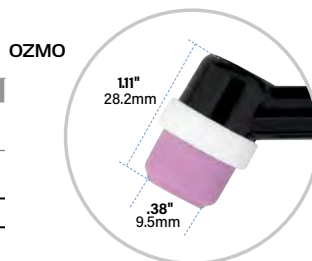

ACCESSORY KIT ONLY KIT-OZMO

180AMP CUT-DOWN

HEAD STYLE	CABLE	CABLE LENGTH	SUPER-FLEX #
RIGID	3 Piece	12.5 ft. (3.8m)	CK24W-12SF-CD
		25 ft. (7.6m)	CK24W-25SF-CD

PARTS TORCH BODY CK24W / HANDLE HS / CABLES 55

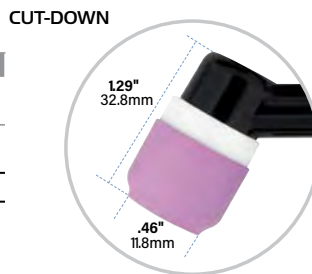

ACCESSORY KIT ONLY KIT-CD



8 Series, OZMO, and Cut-Down Accessory Kits available on page 73 for these torches.

CK20 CK25

250
AMP

WATER COOLED
250 amp ACHF or DCSP @ 100%
2 Series Head Accessories

WATER COOLED



CK20 & CK20V | RIGID

HEAD STYLE	CABLE	CABLE LENGTH	STANDARD #	TRI-FLEX #	SUPER-FLEX #	SPECIFICATIONS
RIGID	3 Piece	12.5 ft. (3.8m)	CK20-12	CK212	CK20-12SF	7-1/2" (19.0cm)
		25 ft. (7.6m)	CK20-25	CK225	CK20-25SF	
RIGID + VALVE	3 Piece	12.5 ft. (3.8m)	CK20V-12	CK212V	CK20V-12SF	3 oz (85gm)
		25 ft. (7.6m)	CK20V-25	CK225V	CK20V-25SF	

PARTS CONSUMABLES 66 / TORCH 75 / HANDLE 75 / CABLES 54 / ADAPTER/DINSE 43-44 & 46

CK20 & CK20V | FLEX

HEAD STYLE	CABLE	CABLE LENGTH	STANDARD #	TRI-FLEX #	SUPER-FLEX #	SPECIFICATIONS
FLEX	3 Piece	12.5 ft. (3.8m)	CK20-12 FX	CK212 FX	CK20-12SF FX	7-1/2" (19.0cm)
		25 ft. (7.6m)	CK20-25 FX	CK225 FX	CK20-25SF FX	
FLEX + VALVE	3 Piece	12.5 ft. (3.8m)	CK20V-12 FX	CK212V FX	CK20V-12SF FX	3 oz (85gm)
		25 ft. (7.6m)	CK20V-25 FX	CK225V FX	CK20V-25SF FX	

PARTS CONSUMABLES 66 / TORCH 75 / HANDLE 75 / CABLES 54 / ADAPTER/DINSE 43-44 & 46

CK20P | PENCIL

HEAD STYLE	CABLE	CABLE LENGTH	STANDARD #	SUPER-FLEX #	SPECIFICATIONS
RIGID	3 Piece	12.5 ft. (3.8m)	CK20P-12	CK20P-12SF	7-1/2" (19.0cm) 3 oz (85gm)
		25 ft. (7.6m)	CK20P-25	CK20P-25SF	

PARTS CONSUMABLES 66 / TORCH 75 / HANDLE 75 / CABLES 54 / ADAPTER/DINSE 43-44 & 46

CK200 | RIGID EXTRA LENGTH SERIES

HEAD STYLE	CABLE	CABLE LENGTH	TRI-FLEX #	SUPER-FLEX #
LONG HEAD 4-1/2" Neck	3 Piece	12.5 ft. (3.8m)	CKL212	CKL212SF
		25 ft. (7.6m)	CKL225	CKL225SF
X-LONG HEAD 7-1/2" Neck	3 Piece	12.5 ft. (3.8m)	CKXL212	CKXL212SF
		25 ft. (7.6m)	CKXL225	CKXL225SF
XX-LONG HEAD 11-1/2" Neck	3 Piece	12.5 ft. (3.8m)	CKXXL212	CKXXL212SF
		25 ft. (7.6m)	CKXXL225	CKXXL225SF

PARTS CONSUMABLES 66 / TORCH 75 / HANDLE 75 / CABLES 54 / ADAPTER/DINSE 43-44 & 46

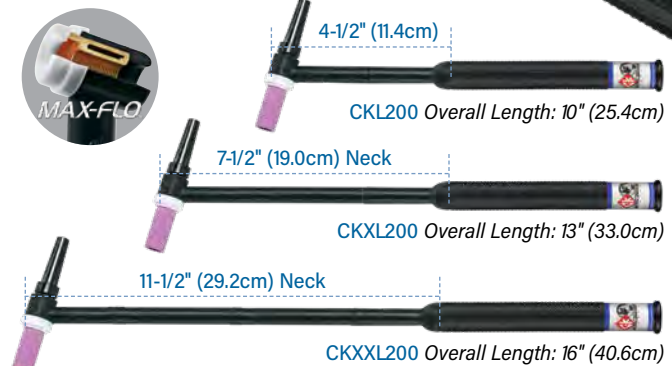

CK25 & CKPF200 | PENCIL FLEX

HEAD STYLE	CABLE	CABLE LENGTH	STANDARD #	TRI-FLEX #	SUPER-FLEX #	SPECIFICATIONS
FLEX	3 Piece	12.5 ft. (3.8m)	CK25-12	CKPF212	CK25-12SF	11-1/2" (29.2cm) 3 oz (85gm)
		25 ft. (7.6m)	CK25-25	CKPF225	CK25-25SF	

PARTS CONSUMABLES 66 / TORCH 75 / HANDLE 75 / CABLES 54 / ADAPTER/DINSE 43-44 & 46



CK18

WATER COOLED
350 amp ACHF or DCSP @ 100%
3 Series Head Accessories



CK18 & CK18V | RIGID

HEAD STYLE	CABLE	CABLE LENGTH	STANDARD #	TRI-FLEX #	SUPER-FLEX #	SPECIFICATIONS
RIGID	3 Piece	12.5 ft. (3.8m)	CK18-12	CK312	CK18-12SF	9-1/2" (24.1cm) 6.5 oz (184gm)
		25 ft. (7.6m)	CK18-25	CK325	CK18-25SF	
RIGID + VALVE	3 Piece	12.5 ft. (3.8m)	CK18V-12	CK312V	CK18V-12SF	6.5 oz (184gm)
		25 ft. (7.6m)	CK18V-25	CK325V	CK18V-25SF	

PARTS CONSUMABLES 67-68 / TORCH 75 / HANDLE 75 / CABLES 54 / ADAPTER/DINSE 43-44 & 46



CK18 & CK18V | FLEX

HEAD STYLE	CABLE	CABLE LENGTH	STANDARD #	TRI-FLEX #	SUPER-FLEX #	SPECIFICATIONS
FLEX	3 Piece	12.5 ft. (3.8m)	CK18-12 FX	CK312 FX	CK18-12SF FX	9-1/2" (24.1cm) 6.5 oz (184gm)
		25 ft. (7.6m)	CK18-25 FX	CK325 FX	CK18-25SF FX	
FLEX + VALVE	3 Piece	12.5 ft. (3.8m)	CK18V-12 FX	CK312V FX	CK18V-12SF FX	6.5 oz (184gm)
		25 ft. (7.6m)	CK18V-25 FX	CK325V FX	CK18V-25SF FX	

PARTS CONSUMABLES 67-68 / TORCH 75 / HANDLE 75 / CABLES 54 / ADAPTER/DINSE 43-44 & 46



CK18P | PENCIL

HEAD STYLE	CABLE	CABLE LENGTH	STANDARD #	SUPER-FLEX #	SPECIFICATIONS
RIGID	3 Piece	12.5 ft. (3.8m)	CK18P-12	CK18P-12SF	9-1/4" (23.5cm) 3 oz (85gm)
		25 ft. (7.6m)	CK18P-25	CK18P-25SF	

PARTS CONSUMABLES 67-68 / TORCH 75 / HANDLE 75 / CABLES 54 / ADAPTER/DINSE 43-44 & 46



3 Series Accessory Kits available on pages 72 & 73 for these torches.



CK18HD

WATER COOLED | HEAVY DUTY
400 amp ACHF or DCSP @ 100%
3 Series Head Accessories

400 AMP WATER COOLED

CK18 & CK18V | HEAVY DUTY

HEAD STYLE	CABLE	CABLE LENGTH	STANDARD #	SUPER-FLEX #	SPECIFICATIONS
RIGID	3 Piece	12.5 ft. (3.8m)	CK18-12-R	CK18-12-RSF	9-1/2" (24.1cm)
		25 ft. (7.6m)	CK18-25-R	CK18-25-RSF	
RIGID + VALVE	3 Piece	12.5 ft. (3.8m)	CK18V-12-R	CK18V-12-RSF	6.5 oz (184gm)
		25 ft. (7.6m)	CK18V-25-R	CK18V-25-RSF	

PARTS CONSUMABLES 67-68 / TORCH 75 / HANDLE 75 / CABLES 54 / ADAPTER/DINSE 43-44 & 46



The CK18 Heavy Duty uses the same torch body as the CK18 and the same power cable as the CK510, located on page 51. Super-Flex part numbers include standard power cable, with Super-Flex argon and water hoses.

GET YOUR GRIND ON!

Our Turbo-Sharp X tungsten grinder makes tungsten preparation quick, easy, and efficient. No more breathing hazardous dust or particles with this multi-angle and completely enclosed unit.



CONSISTENT RESULTS:

Stepless grinding angles 20° - 60°

For more information see page 61.





MasterTIG torches are the highest quality TIG torches available on the market as they include the most cutting-edge designs created by CK Worldwide. These torches were specifically designed to be smaller, lighter, and more compact than our standard line while providing technical advantages that can't be matched.



Look for these exclusive MasterTIG developed TIG technologies throughout this catalog. Each has been developed to maximize efficiencies and performance in TIG applications.



360° HEAD ROTATION

FLEX-LOC™ TORCHES *CK EXCLUSIVE*

Designed to allow ergonomic access to hard-to-reach welds and help prevent carpal tunnel syndrome, these 360-degree variable angle torch heads lock in any position.



CK EXCLUSIVE **TRIM-LINE™ TORCHES**

Trim-Line™ torches were designed to reduce the size and weight of standard 3 Series torches allowing for better maneuverability and comfort when TIG welding. They feature a smaller handle size, and machine side fittings, so that you can use the same amperage as your standard torch while retaining the mobility of a smaller torch such as a 9 or 20.

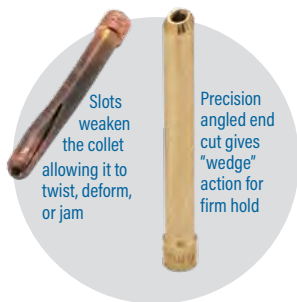

Slots weaken the collet allowing it to twist, deform, or jam

Precision angled end cut gives "wedge" action for firm hold

WEDGE COLLET *CK EXCLUSIVE*

Lasts 10 times longer than standard split collets. Improves arc starts and arc stability. Fits any standard collet body or gas lens, see pages 30-31 and 59.

CK EXCLUSIVE **SUPER CUPS**

For high-amperage and high-reflective heat applications, Super Cups minimize cracking, saving time and money. Available to fit all 2 and 3 Series torches, see pages 64-65.



Lightweight silicone rubber with durable nylon overbraid protection

SUPER-FLEX™ CABLES *CK EXCLUSIVE*

Innovative design replaces heavy, stiff cables to increase range of motion, reducing fatigue and improving productivity. Available for all gas-cooled and water-cooled torches, see pages 51-57.

MICRO TORCH

The Micro Torch is the smallest and most versatile TIG torch on the market! With three angular heads this torch allows multiple options for narrow applications where precision is needed and space is limited. This torch package comes complete with an AK-MR accessory kit and tungsten stick-out gauge.

MR70 | AIR COOLED 70AMP

HEAD STYLE	CABLE	CABLE LENGTH	SUPER-FLEX #
RIGID	1 Piece SUPER-FLEX	12.5 ft. (3.8m)	MR712SF
		25 ft. (7.6m)	MR725SF
PARTS CONSUMABLES 70 / CABLES 52			

MR140 | WATER COOLED 140AMP

HEAD STYLE	CABLE	CABLE LENGTH	SUPER-FLEX #
RIGID	3 Piece SUPER-FLEX	12.5 ft. (3.8m)	MR1412SF
		25 ft. (7.6m)	MR1425SF
PARTS CONSUMABLES 70 / CABLES 54			

- 45°, 90° and 180° interchangeable heads
- .040" (1.0mm), 1/16" (1.6mm) and 3/32" (2.4mm) collets
- 2 Clear cups
- 1 Alumina cup
- 3 Pieces of tungsten (3 different diameters)
- Tungsten installs easily with tungsten gauge and wrench



SPECIFICATIONS:
 Neck Diameter.....0.31" (7.9mm)
 Neck Length.....3.10" (78.7mm)
 Cup Diameter.....0.36" (9.1mm)
 Cup Length.....0.60" (15.2mm)



MICRO TORCH ACCESSORIES

Micro Torch Kit (Part # **AK-MR**) included in torch package



Replacement Parts Accessory Kit on page 70



MR70 & MR140 PARTS

DESCRIPTION	ORDER #	DESCRIPTION	ORDER #	DESCRIPTION	ORDER #
Head 90°	MR90H	Collet .040" (1.0mm)	MR040C	Cup Alumina	MR4A
Head 45°	MR45H	Collet 1/16" (1.6mm)	MR116C	Cup Clear	MR4P
Head 180°	MR180H	Collet 3/32" (2.4mm)	MR332C	Handle Bushing	MRHB

TUNGSTEN | 2% CERATED

DIAMETER	DIAMETER	REPLACEMENT PART #	ACTUAL SIZE PHOTO	SPECIFICATIONS
.040"	1.0mm	T0409S20GC2		LENGTH 0.9" (22.9mm)
1/16"	1.6mm	T1169S20GC2		GRIND 20°
3/32"	2.4mm	T3329S20GC2		QTY. 5/pkg.

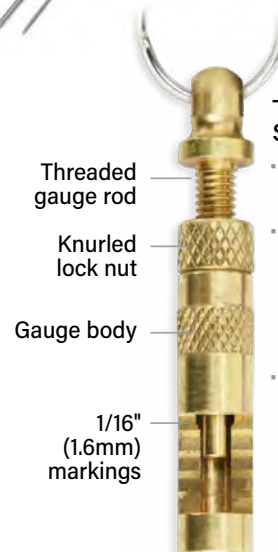

TUNGSTEN STICK-OUT

- Loosen knurled lock nut
- Turn threaded gauge rod to adjust gauge depth, markings are in 1/16" (1.6mm) increments
- Lock gauge by turning knurled lock nut firmly against the gauge body

FL130

GAS COOLED
130 amp ACHF or DCSP @ 100%
2 Series Head Accessories



FL130 & FL130V | FLEX-LOC

HEAD STYLE	CABLE	CABLE LENGTH	STANDARD #	SUPER-FLEX #	SPECIFICATIONS
FL2L	1 Piece	12.5 ft. (3.8m)	FL1312	FL1312SF	7-3/4" (19.6cm)
		25 ft. (7.6m)	FL1325	FL1325SF	
FL2L + VALVE	1 Piece	12.5 ft. (3.8m)	FL1312V	FL1312VSF	4-3/4 oz (135gm)
		25 ft. (7.6m)	FL1325V	FL1325VSF	

PARTS CONSUMABLES 66 / TORCH 74 / HANDLE 74 / CABLES 53 / ADAPTER/DINSE 43-44 & 46

2 Series Accessory Kits available on pages 72 & 73 for these torches.



FL150

GAS COOLED
150 amp ACHF or DCSP @ 100%
3 Series Head Accessories



FL150 & FL150V | FLEX-LOC

HEAD STYLE	CABLE	CABLE LENGTH	STANDARD #	SUPER-FLEX #	SPECIFICATIONS
FL3L	1 Piece	12.5 ft. (3.8m)	FL1512	FL1512SF	8-1/2" (21.6cm)
		25 ft. (7.6m)	FL1525	FL1525SF	
FL3L + VALVE	1 Piece	12.5 ft. (3.8m)	FL1512V	FL1512VSF	7 oz (198gm)
		25 ft. (7.6m)	FL1525V	FL1525VSF	

PARTS CONSUMABLES 67-68 / TORCH 74 / HANDLE 74 / CABLES 53 / ADAPTER/DINSE 43-44 & 46

3 Series Accessory Kits available on pages 72 & 73 for these torches.





CKC150

GAS COOLED
150 amp ACHF or DCSP @ 100%
3 Series Head Accessories

150
AMP

GAS COOLED

CKC150 | CONTRACTOR SPECIAL

HEAD STYLE	CABLE	CABLE LENGTH	STANDARD #	SUPER-FLEX #	SPECIFICATIONS
RIGID	1 Piece	12.5 ft. (3.8m)	CKC1512H	CKC1512HSF	7-3/4" (19.6cm)
		25 ft. (7.6m)	CKC1525H	CKC1525HSF	
	2 Piece	12.5 ft. (3.8m)	CKC1512N	CKC1512NSF	4-1/2 oz (127gm)
		25 ft. (7.6m)	CKC1525N	CKC1525NSF	
RIGID + VALVE	1 Piece	12.5 ft. (3.8m)	CKC1512VH	CKC1512VHSF	STAINLESS STEEL HEAD
		25 ft. (7.6m)	CKC1525VH	CKC1525VHSF	
	2 Piece	12.5 ft. (3.8m)	CKC1512VN	CKC1512VNSF	
		25 ft. (7.6m)	CKC1525VN	CKC1525VNSF	

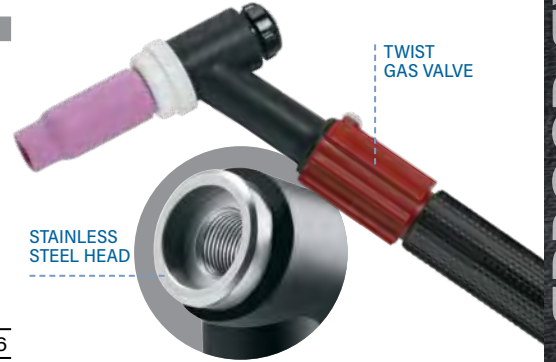

TWIST GAS VALVE

STAINLESS STEEL HEAD

PARTS CONSUMABLES 67-68 / TORCH 75 / HANDLE 75 / CABLES 53 / ADAPTER/DINSE 43-44 & 46



3 Series Accessory Kits available on pages 72 & 73 for these torches.

TL26

GAS COOLED
200 amp ACHF or DCSP @ 100%
3 Series Head Accessories



TL26 & TL26V | RIGID | TRIM-LINE SERIES

HEAD STYLE	CABLE	CABLE LENGTH	STANDARD #	SUPER-FLEX #	SPECIFICATIONS
RIGID	1 Piece	12.5 ft. (3.8m)	TL26-12-R RG	TL26-12-RSF RG	8-1/8" (20.6cm)
		25 ft. (7.6m)	TL26-25-R RG	TL26-25-RSF RG	
	2 Piece	12.5 ft. (3.8m)	TL26-12-2 RG	TL26-12-2SF RG	5 oz (141gm)
		25 ft. (7.6m)	TL26-25-2 RG	TL26-25-2SF RG	
RIGID + VALVE	1 Piece	12.5 ft. (3.8m)	TL26V-12-R RG	TL26V-12-RSF RG	7/8" x 14RH power cable connections
		25 ft. (7.6m)	TL26V-25-R RG	TL26V-25-RSF RG	
	2 Piece	12.5 ft. (3.8m)	TL26V-12-2 RG	TL26V-12-2SF RG	
		25 ft. (7.6m)	TL26V-25-2 RG	TL26V-25-2SF RG	

PARTS CONSUMABLES 67-68 / TORCH 75 / HANDLE 75 / CABLES 52 / ADAPTER/DINSE 43-44 & 46



TL26 & TL26V | FLEX | TRIM-LINE SERIES

HEAD STYLE	CABLE	CABLE LENGTH	STANDARD #	SUPER-FLEX #	SPECIFICATIONS
FLEX	1 Piece	12.5 ft. (3.8m)	TL26-12-R FX	TL26-12-RSF FX	8-1/8" (20.6cm)
		25 ft. (7.6m)	TL26-25-R FX	TL26-25-RSF FX	
	2 Piece	12.5 ft. (3.8m)	TL26-12-2 FX	TL26-12-2SF FX	5 oz (141gm)
		25 ft. (7.6m)	TL26-25-2 FX	TL26-25-2SF FX	
FLEX + VALVE	1 Piece	12.5 ft. (3.8m)	TL26V-12-R FX	TL26V-12-RSF FX	7/8" x 14RH power cable connections
		25 ft. (7.6m)	TL26V-25-R FX	TL26V-25-RSF FX	
	2 Piece	12.5 ft. (3.8m)	TL26V-12-2 FX	TL26V-12-2SF FX	
		25 ft. (7.6m)	TL26V-25-2 FX	TL26V-25-2SF FX	

PARTS CONSUMABLES 67-68 / TORCH 75 / HANDLE 75 / CABLES 52 / ADAPTER/DINSE 43-44 & 46



3 Series Accessory Kits available on pages 72 & 73 for these torches.



FL230

WATER COOLED
230 amp ACHF or DCSP @ 100%
2 Series Head Accessories

FL230 | FLEX-LOC

HEAD STYLE	CABLE	CABLE LENGTH	TRI-FLEX #	SUPER-FLEX #	SPECIFICATIONS
FL2L	3 Piece	12.5 ft. (3.8m)	FL2312	FL2312SF	7-3/4" (19.6cm)
		25 ft. (7.6m)	FL2325	FL2325SF	5 oz (141gm)

PARTS CONSUMABLES 66 / TORCH 74 / HANDLE 74 / CABLES 54 / ADAPTER/DINSE 43-44 & 46

2 Series Accessory Kits available on pages 72 & 73 for these torches.



FL250

WATER COOLED
250 amp ACHF
or DCSP @ 100%
3 Series Head Accessories



FL250 | FLEX-LOC

HEAD STYLE	CABLE	CABLE LENGTH	TRI-FLEX #	SUPER-FLEX #	SPECIFICATIONS
FL3L	3 Piece	12.5 ft. (3.8m)	FL2512	FL2512SF	7-3/4" (19.6cm)
		25 ft. (7.6m)	FL2525	FL2525SF	5 oz (141gm)

PARTS CONSUMABLES 67-68 / TORCH 74 / HANDLE 74 / CABLES 54 / ADAPTER/DINSE 43-44 & 46

3 Series Accessory Kits available on pages 72 & 73 for these torches.



230
AMP

WATER COOLED

250
AMP

CK230

WATER COOLED
 300 amp ACHF or DCSP @ 100%
 2 Series Head Accessories



CK230 & CK230V | HEAVY DUTY

HEAD STYLE	CABLE	CABLE LENGTH	TRI-FLEX #	SUPER-FLEX #	SPECIFICATIONS
RIGID	3 Piece	12.5 ft. (3.8m)	CK2312	CK2312SF	8-1/4" (20.9cm)
		25 ft. (7.6m)	CK2325	CK2325SF	
RIGID + VALVE	3 Piece	12.5 ft. (3.8m)	CK2312V	CK2312VSF	3-3/4 oz (106gm)
		25 ft. (7.6m)	CK2325V	CK2325VSF	

PARTS CONSUMABLES 66 / TORCH 75 / HANDLE 75 / CABLES 55 / ADAPTER/DINSE 43-44 & 46



CK230 & CK230V | FLEX | HEAVY DUTY

HEAD STYLE	CABLE	CABLE LENGTH	TRI-FLEX #	SUPER-FLEX #	SPECIFICATIONS
FLEX	3 Piece	12.5 ft. (3.8m)	CK2312 FX	CK2312SF FX	8-1/4" (20.9cm)
		25 ft. (7.6m)	CK2325 FX	CK2325SF FX	
FLEX + VALVE	3 Piece	12.5 ft. (3.8m)	CK2312V FX	CK2312VSF FX	3-3/4 oz (106gm)
		25 ft. (7.6m)	CK2325V FX	CK2325VSF FX	

PARTS CONSUMABLES 66 / TORCH 75 / HANDLE 75 / CABLES 55 / ADAPTER/DINSE 43-44 & 46



AK-1 ACCESSORY KIT
 9, 20 TORCHES
 1/8" (3.2mm), 3/32" (2.4mm), 1/4" (6.4mm)

Accessories For 2 Series TIG Torch

- 2 Collets
- 3 Collet Bodies
- 3 Caps
- 2 Tungsten Electrodes
- 1 Backcap

www.CKWORLDWIDE.com

AK-4 ACCESSORY KIT
 9, 20 TORCHES
 1/8" (3.2mm), 3/32" (2.4mm), 1/4" (6.4mm)

Accessories For 2 Series TIG Torch

- 3 Collets
- 3 Collet Bodies
- 3 Caps
- 3 Tungsten Electrodes
- 1 Backcap

www.CKWORLDWIDE.com

AK-4GS ACCESSORY KIT
 9, 20 TORCHES
 1/8" (3.2mm), 3/32" (2.4mm), 1/4" (6.4mm)

Accessories For 2 Series TIG Torch

- 3 Collets
- 1 Collet Body
- 3 Adapters
- 1 Heat Shield
- 3 Caps
- 3 Tungsten Electrodes
- 1 Backcap

www.CKWORLDWIDE.com

AK-6 ACCESSORY KIT
 9, 20, 25 TORCHES
 3/32" (2.4mm), 1/8" (3.2mm), 1/4" (6.4mm)

LOW PROFILE Accessories for a 2 Series TIG Torch

- 3 Collets
- 3 Collet Bodies
- 1 Cap
- 3 Tungsten Electrodes
- 2 Backcaps
- 1 Heatshield

www.CKWORLDWIDE.com

2 Series Accessory Kits available on pages 72 & 73 for these torches. Kits allow you to quickly reconfigure your torch based on project requirements to use different tungsten sizes, or convert to Gas-Saver or Stubby.





TL18

WATER COOLED
350 amp ACHF or DCSP @ 100%
3 Series Head Accessories

TL18 & TL18V | RIGID | TRIM-LINE SERIES

HEAD STYLE	CABLE	CABLE LENGTH	STANDARD #	TRI-FLEX #	SUPER-FLEX #	SPECIFICATIONS
RIGID	3 Piece	12.5 ft. (3.8m)	TL18-12	TL312	TL18-12SF	8" (20.3cm)
		25 ft. (7.6m)	TL18-25	TL325	TL18-25SF	5 oz (141gm)

PARTS CONSUMABLES 67-68 / TORCH 75 / HANDLE 75 / CABLES 55 / ADAPTER/DINSE 43-44 & 46



TL18 & TL18V | FLEX | TRIM-LINE SERIES

HEAD STYLE	CABLE	CABLE LENGTH	STANDARD #	TRI-FLEX #	SUPER-FLEX #	SPECIFICATIONS
FLEX	3 Piece	12.5 ft. (3.8m)	TL18-12 FX	TL312 FX	TL18-12SF FX	8" (20.3cm)
		25 ft. (7.6m)	TL18-25 FX	TL325 FX	TL18-25SF FX	5 oz (141gm)

PARTS CONSUMABLES 67-68 / TORCH 75 / HANDLE 75 / CABLES 55 / ADAPTER/DINSE 43-44 & 46



3 Series Accessory Kits available on pages 72 & 73 for these torches.

CK510

WATER COOLED
500 amp ACHF or DCSP @ 100%
3 or 51 Series Head Accessories



CK510 | HEAVY DUTY

HEAD STYLE	CABLE	CABLE LENGTH	STANDARD #	SUPER-FLEX #	SPECIFICATIONS
RIGID	3 Piece	12.5 ft. (3.8m)	CK5112	CK5112SF	9-1/4" (23.5cm)
		25 ft. (7.6m)	CK5125	CK5125SF	
RIGID + VALVE	3 Piece	12.5 ft. (3.8m)	CK5112V	CK5112VSF	6-3/4 oz (191gm)
		25 ft. (7.6m)	CK5125V	CK5125VSF	

PARTS CONSUMABLES 67/69 / TORCH 75 / HANDLE 75 / CABLES 55 / ADAPTER/DINSE 43-44 & 46



SMALLEST 500 AMP TORCH IN THE WORLD!

Uses .020" ~ 1/4" (0.5mm ~ 6.4mm) Tungsten

CK510 Super-Flex part numbers include standard power cable, with Super-Flex argon and water hoses.

150 AMP

GAS COOLED

200 AMP



USFL130 USFL150

GAS COOLED

130/150 amp ACHF or DCSP @ 100%

2 & 3 Series Head Accessories

Flex-Loc FL2L and FL3L heads included, allowing torch to operate at 130 amps or 150 amps as needed.

USFL130/USFL150 | FLEX-LOC™

HEAD STYLE	CABLE	CABLE LENGTH	SUPER-FLEX #	SPECIFICATIONS
FLEX-LOC FL2L & FL3L	SUPER-FLEX	12.5 ft. (3.8m)	USFL1312SF	WITH FL2L 8-5/8" (21.9cm) 5-1/4 oz (150gm)
		25 ft. (7.6m)	USFL1325SF	WITH FL3L 9-1/8" (23.2cm) 6-1/3 oz (180gm)

Note: Measured from heatshield to back of handle, does not include cable or consumable/accessory weight.

PARTS CONSUMABLES 66-68 / TORCH 74 / CABLES 53 / ADAPTER/DINSE 43-44 & 46



360° HEAD ROTATION



KIT INCLUDES:

- Textured torch handle
- Steady-Grip™ ergonomic handle
- Ball strain relief
- Super-Flex™ cable
- Leather hose cover
- FL2L and FL3L heads
- ULT-FL accessory kit complete with Gas Saver™ parts

USTL210

GAS COOLED

200 amp ACHF or DCSP @ 100%

3 Series Head Accessories

USTL210 | TRIM-LINE™

HEAD STYLE	CABLE	CABLE LENGTH	SUPER-FLEX #	SPECIFICATIONS
RIGID	SUPER-FLEX	12.5 ft. (3.8m)	USTL2112SF	9-3/8" (23.8cm) 5-1/4 oz (150gm)
		25 ft. (7.6m)	USTL2125SF	
FLEX	SUPER-FLEX	12.5 ft. (3.8m)	USTL2112SF FX	<i>Note: Measured from heatshield to back of handle, does not include cable or consumable/accessory weight.</i>
		25 ft. (7.6m)	USTL2125SF FX	

PARTS CONSUMABLES 67-68 / TORCH 75 / CABLES 52 / ADAPTER/DINSE 43-44 & 46



KIT INCLUDES:

- Textured torch handle
- Steady-Grip™ ergonomic handle
- Ball strain relief
- Super-Flex™ cable
- Leather hose cover
- ULT-3 accessory kit complete with Gas Saver™ parts

UltraTIG Series torch packages include one of the following kits, depending on the torch ordered:



MADE IN THE U.S.A.

USFL230 USFL250

WATER COOLED

230/250 amp ACHF or DCSP @ 100%

2 or 3 Series Head Accessories

Flex-Loc FL2L and FL3L heads included, allowing torch to operate at 130 amps or 150 amps as needed.

USFL230/USFL250 | FLEX-LOC™

HEAD STYLE	CABLE	CABLE LENGTH	SUPER-FLEX #	SPECIFICATIONS
FLEX-LOC FL2L & FL3L	SUPER-FLEX	12.5 ft. (3.8m)	USFL2312SF	WITH FL2L* 8-5/8" (21.9cm) 4-3/4 oz (135gm)
		25 ft. (7.6m)	USFL2325SF	WITH FL3L* 9-1/8" (23.2cm) 5-2/3 oz (160gm) <i>*Argon/water lines are 18" longer than power cable</i>



Note: Measured from heatshield to back of handle, does not include cable or consumable/accessory weight.



360° HEAD ROTATION

KIT INCLUDES:

- Textured torch handle
- Steady-Grip™ ergonomic handle
- Ball strain relief
- Super-Flex™ cables
- Leather hose cover
- Gas and water hose quick disconnects
- FL2L and FL3L heads
- ULT-FL accessory kit complete with Gas Saver™ parts

PARTS CONSUMABLES 64-68 / TORCH 74 / CABLES 54 / ADAPTER/DINSE 43-44 & 46

US230

WATER COOLED

230 amp ACHF or DCSP @ 100%

2 Series Head Accessories

KIT INCLUDES:

- Textured torch handle
- Steady-Grip™ ergonomic handle
- Ball strain relief
- Super-Flex™ cables
- Leather hose cover
- Gas and water hose quick disconnects
- ULT-2 accessory kit complete with Gas Saver™ parts

US230 | HEAVY DUTY

HEAD STYLE	CABLE	CABLE LENGTH	SUPER-FLEX #	SPECIFICATIONS
RIGID	SUPER-FLEX	12.5 ft. (3.8m)	US2312SF	9-3/8" (23.8cm) 4-1/4 oz (120gm)
		25 ft. (7.6m)	US2325SF	<i>Argon/water lines are 18" longer than power cable</i>
FLEX	SUPER-FLEX	12.5 ft. (3.8m)	US2312SF FX	<i>Note: Measured from heatshield to back of handle, does not include cable or consumable/accessory weight.</i>
		25 ft. (7.6m)	US2325SF FX	

CONSUMABLES 66 / TORCH 75 / CABLES 55 / ADAPTER/DINSE 43-44 & 46



MAX-FLO

USTL300

WATER COOLED

350 amp ACHF or DCSP @ 100%

3 Series Head Accessories

KIT INCLUDES:

- Textured torch handle
- Steady-Grip™ ergonomic handle
- Ball strain relief
- Super-Flex™ cables
- Leather hose cover
- Gas and water hose quick disconnects
- ULT-3 accessory kit complete with Gas Saver™ parts

USTL300 | TRIM-LINE™

HEAD STYLE	CABLE	CABLE LENGTH	SUPER-FLEX #	SPECIFICATIONS
RIGID	SUPER-FLEX	12.5 ft. (3.8m)	USTL312SF	9-3/8" (23.8cm) 5-1/2 oz (155gm)
		25 ft. (7.6m)	USTL325SF	<i>Argon/water lines are 18" longer than power cable</i>
FLEX	SUPER-FLEX	12.5 ft. (3.8m)	USTL312SF FX	<i>Note: Measured from heatshield to back of handle, does not include cable or consumable/accessory weight.</i>
		25 ft. (7.6m)	USTL325SF FX	

CONSUMABLES 66 / TORCH 75 / CABLES 55 / ADAPTER/DINSE 43-44 & 46



250 AMP

WATER COOLED

300 AMP

350 AMP

STANDARD & STUBBY GAS SAVER™ KITS

Use these conversion kits and save up to 40% of shield gas consumption plus save money on replacement parts.

- Provides better gas coverage versus standard collet bodies
- Tungsten stick-out can be up to 6 times the electrode diameter
- Clear or Alumina push on nozzles available
- Improves visibility
- Less expensive replacement parts than standard gas lenses
- Fits most standard silicone rubber insulated torch bodies
- Replaceable screen adapter

SAVE UP TO 40%
of shield gas consumption

KITS INCLUDE WEDGE COLLET

2 SERIES | STANDARD | GAS SAVER KITS

TORCHES	TUNGSTEN	CUP TYPE/SIZE	ORDER #
CK9, CK20 (2 SERIES)	1/16" (1.6mm)	ALUMINA/Size 5	D2GS116
	3/32" (2.4mm)	ALUMINA/Size 6	D2GS332
	1/8" (3.2mm)	ALUMINA/Size 7	D2GS418
	1/16" (1.6mm)	CLEAR/Size 8	D2GS116-P
	3/32" (2.4mm)	CLEAR/Size 8	D2GS332-P
	1/8" (3.2mm)	CLEAR/Size 8	D2GS418-P

COMPLETE FRONT-END KIT INCLUDES ITEMS BELOW (ONE EACH):

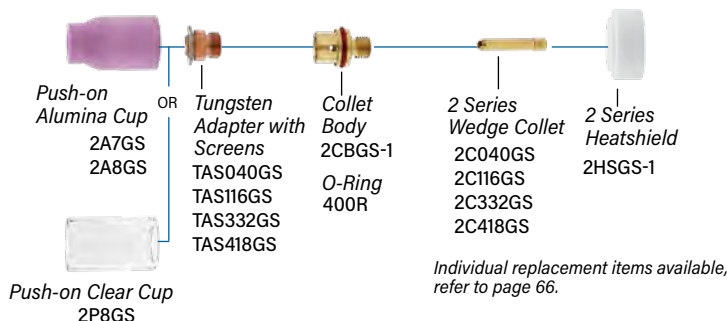

3 SERIES | STANDARD | GAS SAVER KITS

TORCHES	TUNGSTEN	CUP TYPE/SIZE	ORDER #
CK17, CK18, CK26 (3 SERIES)	1/16" (1.6mm)	ALUMINA/Size 5	D3GS116
	3/32" (2.4mm)	ALUMINA/Size 6	D3GS332
	1/8" (3.2mm)	ALUMINA/Size 7	D3GS418
	1/16" (1.6mm)	CLEAR/Size 8	D3GS116-P
	3/32" (2.4mm)	CLEAR/Size 8	D3GS332-P
	1/8" (3.2mm)	CLEAR/Size 8	D3GS418-P

COMPLETE FRONT-END KIT INCLUDES ITEMS BELOW (ONE EACH):

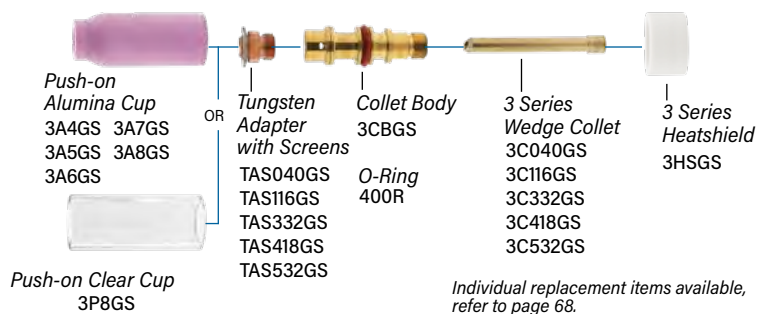

4 SERIES | STUBBY | GAS SAVER KITS

TORCHES	TUNGSTEN	CUP TYPE/SIZE	ORDER #
CK17, CK18, CK26 (3 SERIES)	1/16" (1.6mm)	ALUMINA/Size 5	D4GS116
	3/32" (2.4mm)	ALUMINA/Size 6	D4GS332
	1/8" (3.2mm)	ALUMINA/Size 7	D4GS418
	1/16" (1.6mm)	CLEAR/Size 8	D4GS116-P
	3/32" (2.4mm)	CLEAR/Size 8	D4GS332-P
	1/8" (3.2mm)	CLEAR/Size 8	D4GS418-P

COMPLETE FRONT-END KIT INCLUDES ITEMS BELOW (ONE EACH):

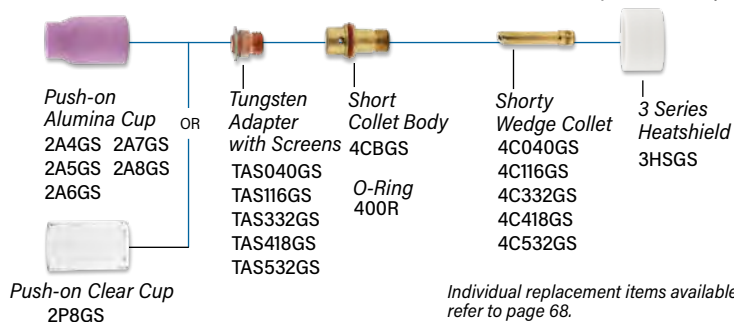

LARGE DIAMETER GAS SAVER™ KITS

Alloys such as Titanium that require extra shield gas coverage are now being used for aerospace and motorsport components. Standard and large diameter gas lenses are not adequate to insure a larger surface area of shield gas coverage. CK Worldwide's Large Diameter Gas Saver™ is ideal for titanium tubing. High-temperature clear glass gas cups insure full visibility of the weld puddle and directs a uniform gas flow pattern over a very large surface area.

Aerospace and motorsport components present odd angles that need to be welded. Standard tungsten stick-out beyond the gas cup does not allow the torch to be put in the proper position to weld those angles. The Large Diameter Gas Saver™ allows the tungsten to extend up to 1-1/2" (3.81cm) beyond the edge of the gas cup giving the welder the ability to access the weld without getting the torch into the angle.



GREAT FOR TITANIUM!

- Improved visibility allows odd-angle welding
- Tungsten stick-out can extend up to 1-1/2" (3.81cm) beyond the edge of the gas cup
- Clear or Alumina push on nozzles available
- Less expensive replacement parts than standard gas lenses
- Fits most standard silicone rubber insulated torch bodies
- Replaceable screen adapter

2 SERIES | LRG. DIAMETER | GAS SAVER KITS

TORCHES	TUNGSTEN	CUP TYPE/SIZE	ORDER #
CK9, CK20 (2 SERIES)	1/16" (1.6mm)	ALUMINA/Size 18	D2GS116LD-A
	3/32" (2.4mm)	ALUMINA/Size 18	D2GS332LD-A
	1/8" (3.2mm)	ALUMINA/Size 18	D2GS418LD-A
	1/16" (1.6mm)	CLEAR/Size 18	D2GS116LD
	3/32" (2.4mm)	CLEAR/Size 18	D2GS332LD
	1/8" (3.2mm)	CLEAR/Size 18	D2GS418LD

COMPLETE FRONT-END KIT INCLUDES ITEMS BELOW (ONE EACH):

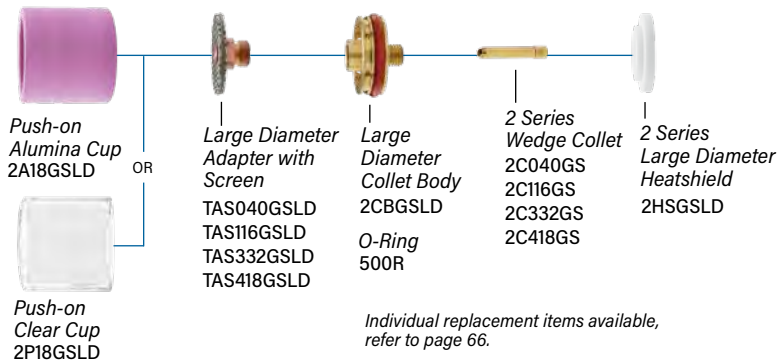

3 SERIES | LRG. DIAMETER | GAS SAVER KITS

TORCHES	TUNGSTEN	CUP TYPE/SIZE	ORDER #
CK17, CK18, CK26 (3 SERIES)	1/16" (1.6mm)	ALUMINA/Size 18	D4GS116LD-A
	3/32" (2.4mm)	ALUMINA/Size 18	D4GS332LD-A
	1/8" (3.2mm)	ALUMINA/Size 18	D4GS418LD-A
	1/16" (1.6mm)	CLEAR/Size 18	D4GS116LD
	3/32" (2.4mm)	CLEAR/Size 18	D4GS332LD
	1/8" (3.2mm)	CLEAR/Size 18	D4GS418LD

COMPLETE FRONT-END KIT INCLUDES ITEMS BELOW (ONE EACH):

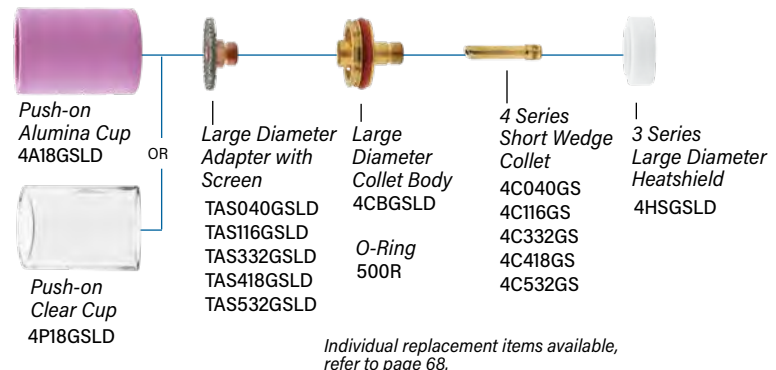

COLD WIRE FEEDER

Automate the addition of filler metal with the touch of a button using the WF-5 Cold Wire Feeder. This machine works independently to provide continuous filler metal for your TIG welding needs.

- Increases productivity
- Automates adding of filler metal
- All parameters can be duplicated for consistency
- Dual groove drive roll accepts multiple wire sizes
- Accepts standard wire spool sizes
- Eliminates filler rod stub loss
- Machine cover keeps filler metal clean and uncontaminated
- Makes fully-automated, or one-handed, TIG welding possible

Note: For complete installation of a Cold Wire Feed system you need both the Cold Wire Feeder and a Wire Feed Application method, such as those listed below, in conjunction with your welding machine. The Cold Wire Feeder works independently and needs its own power source.



WF-5 FRONT PANEL CONTROLS

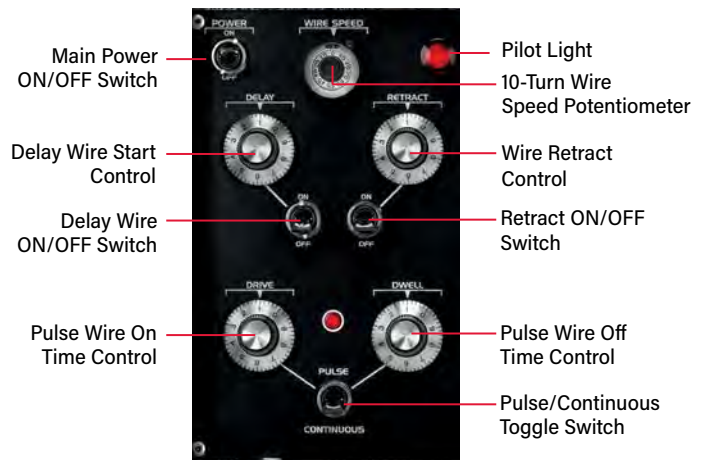

WF5 COLD WIRE FEED UNIT | CK EXCLUSIVE

APPLICATION	DRIVE ROLL	WIRE SIZE	ORDER #
HAND HELD/ MACHINE MOUNTED	30-45DR	.030" - .045" (.8mm-1.1mm)	WF5-035
	30-45DR	.030" - .045" (.8mm-1.1mm)	WF5-045
	45-564DR	.045" - 1/16" (1.1mm-1.6mm)	WF5-116

WIRE FEED APPLICATIONS



WF-5 SPECIFICATIONS

Voltage..... 115V AC (220V AC 50 Hz. – Special Order)
 Phase..... Single Phase
 Frequency..... 50/60 Hz.
 Height..... 15" (38.1cm)
 Width..... 10" (25.4cm)
 Length..... 21" (53.3cm)
 Weight..... 54 lbs. (24.5kg)
 Filler Wire Spool Size..... 12" (30.5cm)
 Filler Wire Sizes..... .023" (.5mm), .030" (.8mm),
 .035" (.9mm), .045" (1.1mm), 1/16" (1.6mm)
 Wire Feed Speed Range... 0-700 in/min (0-1,775cm/min)
 Feed Time (pulsed mode)..... continuously variable
 Dwell Time (pulsed mode)..... continuously variable
 Delay Start Time..... continuously variable
 Wire Retract Time..... continuously variable

HANDHELD PENDANT

CWH PENDANT |

HEAD STYLE	LENGTH	WIRE SIZE / TYPE	ORDER#	SPECIFICATIONS
ELECTRIC SWITCH W/ STRAIGHT WIRE GUIDE	8 ft. (2.4m)	.030" (.8mm) / Soft	CWH-030S	Pendant unit
	10 ft. (3.0m)	.030" (.8mm) / Hard	CWH-030H	Used in conjunction with TIG torch
	8 ft. (2.4m)	.035" (.9mm) / Soft	CWH-035S	
	10 ft. (3.0m)	.035" (.9mm) / Hard	CWH-035H	Standard feed cable length: 10' hard wire (3m) 8' soft wire (2.4m)
	8 ft. (2.4m)	.045" (1.1mm) / Soft	CWH-045S	
	10 ft. (3.0m)	.045" (1.1mm) / Hard	CWH-045H	
	8 ft. (2.4m)	1/16" (1.6mm) / Soft	CWH-116S	
	10 ft. (3.0m)	1/16" (1.6mm) / Hard	CWH-116H	

COLD WIRE TORCHES

CWH1812 COLD WIRE | WATER COOLED | 180AMP

STYLE	WIRE SIZE / TYPE	TRI-FLEX #	SUPER-FLEX #	SPECIFICATIONS
RIGID W/OUT VALVE	.030" (.8mm) / Soft	CWH1812-030S	CWH1812SF-030S	180 amp ACHF or DCSP @ 100%
	.030" (.8mm) / Hard	CWH1812-030H	CWH1812SF-030H	
	.035" (.9mm) / Soft	CWH1812-035S	CWH1812SF-035S	8-1/8" (20.6cm)
12.5 ft. (3.8m) Tri-Flex or Super-Flex Cables	.035" (.9mm) / Hard	CWH1812-035H	CWH1812SF-035H	3-1/2 oz. (99gm)
	.045" (1.1mm) / Soft	CWH1812-045S	CWH1812SF-045S	8 Series Head Accessories
	.045" (1.1mm) / Hard	CWH1812-045H	CWH1812SF-045H	
	1/16" (1.6mm) / Soft	CWH1812-116S	CWH1812SF-116S	
	1/16" (1.6mm) / Hard	CWH1812-116H	CWH1812SF-116H	

CWH2312 COLD WIRE | WATER COOLED | 300AMP

STYLE	WIRE SIZE / TYPE	TRI-FLEX #	SUPER-FLEX #	SPECIFICATIONS
RIGID W/OUT VALVE	.030" (.8mm) / Soft	CWH2312-030S	CWH2312SF-030S	300 amp ACHF or DCSP @ 100%
	.030" (.8mm) / Hard	CWH2312-030H	CWH2312SF-030H	
	.035" (.9mm) / Soft	CWH2312-035S	CWH2312SF-035S	8-1/4" (20.9cm)
12.5 ft. (3.8m) Tri-Flex or Super-Flex Cables	.035" (.9mm) / Hard	CWH2312-035H	CWH2312SF-035H	3-3/4 oz. (106gm)
	.045" (1.1mm) / Soft	CWH2312-045S	CWH2312SF-045S	2 Series Head Accessories
	.045" (1.1mm) / Hard	CWH2312-045H	CWH2312SF-045H	
	1/16" (1.6mm) / Soft	CWH2312-116S	CWH2312SF-116S	
	1/16" (1.6mm) / Hard	CWH2312-116H	CWH2312SF-116H	

CWHTL312 COLD WIRE | WATER COOLED | 350AMP

STYLE	WIRE SIZE / TYPE	TRI-FLEX #	SUPER-FLEX #	SPECIFICATIONS
RIGID W/OUT VALVE	.030" (.8mm) / Soft	CWHTL312-030S	CWHTL312SF-030S	350 amp ACHF or DCSP @ 100%
	.030" (.8mm) / Hard	CWHTL312-030H	CWHTL312SF-030H	
	.035" (.9mm) / Soft	CWHTL312-035S	CWHTL312SF-035S	8" (20.3cm)
12.5 ft. (3.8m) Tri-Flex or Super-Flex Cables	.035" (.9mm) / Hard	CWHTL312-035H	CWHTL312SF-035H	5 oz. (141gm)
	.045" (1.1mm) / Soft	CWHTL312-045S	CWHTL312SF-045S	3 Series Head Accessories
	.045" (1.1mm) / Hard	CWHTL312-045H	CWHTL312SF-045H	
	1/16" (1.6mm) / Soft	CWHTL312-116S	CWHTL312SF-116S	
	1/16" (1.6mm) / Hard	CWHTL312-116H	CWHTL312SF-116H	

CWH3512 COLD WIRE | WATER COOLED | 400AMP

STYLE	WIRE SIZE / TYPE	3-PIECE VINYL #	SUPER-FLEX #	SPECIFICATIONS
RIGID W/OUT VALVE	.030" (.8mm) / Soft	CWH3512-030S	CWH3512SF-030S	400 amp ACHF or DCSP @ 100%
	.030" (.8mm) / Hard	CWH3512-030H	CWH3512SF-030H	
	.035" (.9mm) / Soft	CWH3512-035S	CWH3512SF-035S	9-1/2" (24.1cm)
12.5 ft. (3.8m) 3-Piece Vinyl or Super-Flex Cables	.035" (.9mm) / Hard	CWH3512-035H	CWH3512SF-035H	6-1/2 oz. (184gm)
	.045" (1.1mm) / Soft	CWH3512-045S	CWH3512SF-045S	3 Series Head Accessories
	.045" (1.1mm) / Hard	CWH3512-045H	CWH3512SF-045H	
	1/16" (1.6mm) / Soft	CWH3512-116S	CWH3512SF-116S	
	1/16" (1.6mm) / Hard	CWH3512-116H	CWH3512SF-116H	



COLD WIRE TORCHES

COLD WIRE TORCHES MACHINE MOUNTED



When these torches are used in conjunction with the WF-5 wire feeder, complete automatic feeding of the filler wire is possible.

Please specify size: .030" (.8mm), .035" (.9mm), .045" (1.1mm), 1/16" (1.6mm)
And type: (HARD – steel or SOFT – aluminum) when ordering.

A separate remote switch (CWMES) is required for complete installation.
Standard feed cable length: 8 ft. (2.4m) for soft wire, and 10 ft. (3m) for hard wire.

CWM2312 MACHINE COLD WIRE TORCH WATER COOLED | 300 AMP

HEAD STYLE	CABLE	WIRE SIZE / TYPE	TRI-FLEX #	SPECIFICATIONS
BARREL FRONT LOAD	12-1/2 ft. (3.8m) Tri-Flex	.030" (.8mm) / Soft	CWM2312-030S	300 amp ACHF or DCSP @ 100%
		.030" (.8mm) / Hard	CWM2312-030H	
		.035" (.9mm) / Soft	CWM2312-035S	18" (45.7cm)
		.035" (.9mm) / Hard	CWM2312-035H	6 oz. (170gm)
	Special length cables are available upon request.	.045" (1.1mm) / Soft	CWM2312-045S	1-3/8" (35mm) O.D. Barrel
		.045" (1.1mm) / Hard	CWM2312-045H	2 Series Head Accessories
		1/16" (1.6mm) / Soft	CWM2312-116S	
		1/16" (1.6mm) / Hard	CWM2312-116H	



CWM3512 MACHINE COLD WIRE TORCH WATER COOLED | 350 AMP

HEAD STYLE	CABLE	WIRE SIZE / TYPE	ORDER #	SPECIFICATIONS
BARREL FRONT LOAD	12-1/2 ft. (3.8m)	.030" (.8mm) / Soft	CWM3512-030S	350 amp ACHF or DCSP @ 100%
		.030" (.8mm) / Hard	CWM3512-030H	
	Separate Cables	.035" (.9mm) / Soft	CWM3512-035S	18" (45.7cm)
		.035" (.9mm) / Hard	CWM3512-035H	6 oz. (170gm)
	Special length cables are available upon request.	.045" (1.1mm) / Soft	CWM3512-045S	1-3/8" (35mm) O.D. Barrel
		.045" (1.1mm) / Hard	CWM3512-045H	3 Series Head Accessories
		1/16" (1.6mm) / Soft	CWM3512-116S	
		1/16" (1.6mm) / Hard	CWM3512-116H	



CWM412 MACHINE COLD WIRE TORCH WATER COOLED | 400 AMP

HEAD STYLE	CABLE	WIRE SIZE / TYPE	ORDER #	SPECIFICATIONS
SCREW MOUNTED FRONT AND BACK LOAD	12-1/2 ft. (3.8m)	.030" (.8mm) / Soft	CWMT412-030S	400 amp ACHF or DCSP @ 100%
		.030" (.8mm) / Hard	CWMT412-030H	
	Separate Cables	.035" (.9mm) / Soft	CWMT412-035S	4-1/16" (10.3cm)
		.035" (.9mm) / Hard	CWMT412-035H	6-1/4 oz. (177gm)
	Special length cables are available upon request.	.045" (1.1mm) / Soft	CWMT412-045S	Machine Series Head Accessories (see page 75)
		.045" (1.1mm) / Hard	CWMT412-045H	
		1/16" (1.6mm) / Soft	CWMT412-116S	
		1/16" (1.6mm) / Hard	CWMT412-116H	



CWMT512 MACHINE COLD WIRE TORCH WATER COOLED | 500 AMP

HEAD STYLE	CABLE	WIRE SIZE / TYPE	ORDER #	SPECIFICATIONS
7" (17.8cm) or 18" (45.7cm) Barrel* BACK LOAD ONLY	12-1/2 ft. (3.8m)	.030" (.8mm) / Soft	CWMT512-7-030S	500 amp ACHF or DCSP @ 100%
		.030" (.8mm) / Hard	CWMT512-7-030H	
	Separate Cables	.035" (.9mm) / Soft	CWMT512-7-035S	7" (17.8cm)
		.035" (.9mm) / Hard	CWMT512-7-035H	12 oz. (340gm)
	Special length cables are available upon request.	.045" (1.1mm) / Soft	CWMT512-7-045S	Machine Series Head Accessories (see page 75)
		.045" (1.1mm) / Hard	CWMT512-7-045H	
		1/16" (1.6mm) / Soft	CWMT512-7-116S	
		1/16" (1.6mm) / Hard	CWMT512-7-116H	



*Contact CK Worldwide for 18 inch (45.7cm) barrel part numbers.

TOLL FREE: (800) 426.0877 | www.CKWORLDWIDE.com

COLD WIRE CONDUITS AND WIRE GUIDES

The chart below can be used for finding part numbers based on the torch and size/type of wire that is being used. Our standard lengths for the Wire Conduit is 8 ft. (2.4m) for SOFT wire, and 10 ft. (3m) for HARD wire to help prevent feeding problems.

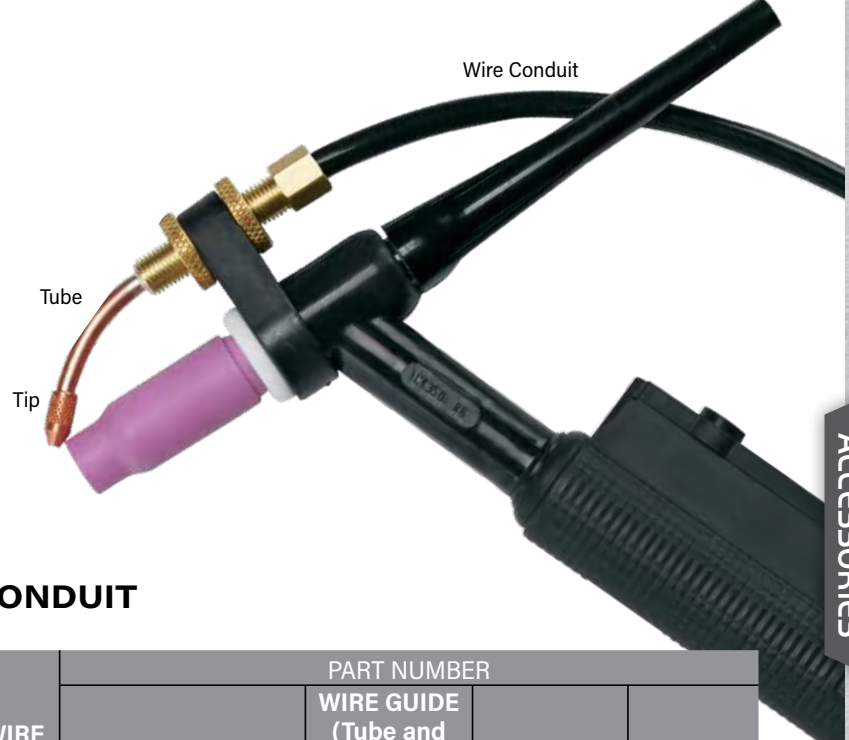

RECOMMENDED COLD WIRE CONDUIT AND WIRE GUIDES

TIG TORCH	WIRE SIZE	WIRE TYPE	PART NUMBER			
			WIRE CONDUIT	WIRE GUIDE (Tube and Tip)	TUBE	TIP
<i>Body Mounted</i> CWH180 CWH230 CWM230	.023" (.5 mm) - .030" (.8 mm)	Hard	CW-FC	CWG030B	CWGB	CWT030
	.023" (.5 mm) - .030" (.8 mm)	Soft	NOT RECOMMENDED	N/A	N/A	N/A
	.035" (.9 mm)	Hard	CW-FC	CWG035B	CWGB	CWT035
	.035" (.9 mm)	Soft	CW-FCN	CWG035B	CWGB	CWT035
	.045" (1.1 mm)	Hard	CW-FC	CWG045B	CWGB	CWT045
	3/64" (1.2 mm)	Soft	CW-FCN116	CWG116B	NONE	NONE
<i>Front Mounted</i> CWHTL300 CWH350 CWM350 CWMT400 CWMT500	.023" (.5 mm) - .030" (.8 mm)	Hard	CW-FC	CWG030H	CWGH	CWT030
	.023" (.5 mm) - .030" (.8 mm)	Soft	NOT RECOMMENDED	N/A	N/A	N/A
	.035" (.9 mm)	Hard	CW-FC	CWG035H	CWGH	CWT035
	.035" (.9 mm)	Soft	CW-FCN	CWG035H	CWGH	CWT035
	.045" (1.1 mm)	Hard	CW-FC	CWG045H	CWGH	CWT045
	3/64" (1.2 mm)	Soft	CW-FCN116	CWG116H	NONE	NONE
	1/16" (1.6 mm)	Hard	CW-FC116	CWG116H	NONE	NONE
	1/16" (1.6 mm)	Soft	CW-FCN116	CWG116H	NONE	NONE
CWH	.023" (.5 mm) - .030" (.8 mm)	Hard	CW-FC	CWG030HS	CWGHS	CWT030
	.023" (.5 mm) - .030" (.8 mm)	Soft	CW-FCN	CWG030HS	CWGHS	CWT030
	.035" (.9 mm)	Hard	CW-FC	CWG035HS	CWGHS	CWT035
	.035" (.9 mm)	Soft	CW-FCN	CWG035HS	CWGHS	CWT035
	.045" (1.1 mm)	Hard	CW-FC	CWG045HS	CWGHS	CWT045
	3/64" (1.2 mm)	Soft	CW-FCN116	CWG116HS	NONE	NONE
	1/16" (1.6 mm)	Hard	CW-FC116	CWG116HS	NONE	NONE
	1/16" (1.6 mm)	Soft	CW-FCN116	CWG116HS	NONE	NONE

COLD WIRE EXTENSION BRACKET

- Used for multiple different angles
- Works well with both soft and hard wire types
- Increases the feedability of the wire



ORDER # 3-WGBX-60



MACHINE ROBOTIC TORCHES

Largest Line of Machine Robotic Torches

- All torches are back-loaded, no need to remove cup to make adjustments
- Adjust tungsten up to 3/4" (19mm) without removing tungsten from torch (MT100, MT400)
- Uses standard 10N Series cup and collet body, 10N "stubby" collet
- High temperature phenolic resin insulation

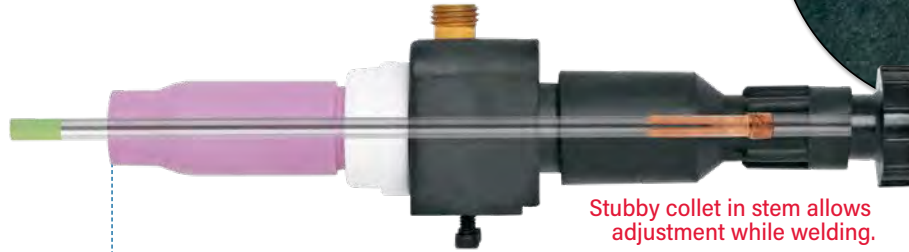

5.75" (14.6cm) See Stubby 4 Series slotted collets on page 70

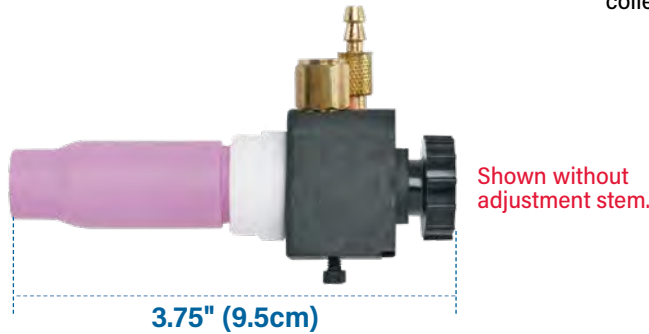

MT100 | GAS COOLED | COMPACT | 100 AMP

HEAD STYLE	CABLE	CABLE LENGTH	STANDARD #	SUPER-FLEX#	SPECIFICATIONS
FACE PLATE MOUNTED	1 Piece	12.5 ft. (3.8m)	MT112	MT112SF	4-1/16" (10.3cm) 5-3/4 oz (163gm)
	1 Piece	25 ft. (7.6m)	MT125	MT125SF	Machine Series Head Accessories (4 Series Collet)

PARTS MT CONSUMABLES 70 / TORCH 75 / CABLES 57 / ADAPTER/DINSE 43-44 & 46



MT400 | WATER COOLED | COMPACT | 400 AMP

HEAD STYLE	CABLE	CABLE LENGTH	STANDARD #	SUPER-FLEX#	SPECIFICATIONS
FACE PLATE MOUNTED	3 Piece	12.5 ft. (3.8m)	MT412-1	MT412SF-1	4-1/16" (10.3cm) 6-1/4 oz (177gm)
	3 Piece	25 ft. (7.6m)	MT425-1	MT425SF-1	Machine Series Head Accessories (4 Series Collet)

PARTS MT CONSUMABLES 70 / TORCH 75 / CABLES 57 / ADAPTER/DINSE 43-44 & 46

*90 Degree power cable elbow available - 90EMT300



BARREL MACHINE TORCHES

FRONT OR BACK LOADING SERIES

The MT500 Series torch body is available in lengths of 7" (17.8cm) or 18" (45.7cm) with a 1-3/8" (35mm) O.D. The unique adjusting cap design of the MT torches provides 1/2" (12.7mm) tungsten adjustment while welding, and for ease of setup. A factory-installed 24 or 32 pitch rack is available on 18" (45.7cm) version only.

MT500-7 | WATER COOLED | 500 AMP

HEAD STYLE	CABLE	CABLE LENGTH	STANDARD#	SUPER-FLEX#	SPECIFICATIONS
BARREL STYLE	3 Piece	12.5 ft. (3.8m)	MT512-7-1	MT512SF-7-1	7" (17.8cm) 12 oz (340gm) 1-3/8" (35mm) O.D. Barrel
	3 Piece	25 ft. (7.6m)	MT525-7-1	MT525SF-7-1	Machine Series Head Accessories (4 Series Collet)

PARTS MT CONSUMABLES 70 / TORCH 75 / CABLES 57 / ADAPTER/DINSE 43-44 & 46



500 Amps

MT500-18 | WATER COOLED | 500 AMP

HEAD STYLE	CABLE	CABLE LENGTH	STANDARD#	SUPER-FLEX#	SPECIFICATIONS
BARREL STYLE	3 Piece	12.5 ft. (3.8m)	MT512-18-1	MT512SF-18-1	18" (45.7cm) 16 oz (454gm) 1-3/8" (35mm) O.D. Barrel
	3 Piece	25 ft. (7.6m)	MT525-18-1	MT525SF-18-1	Machine Series Head Accessories (4 Series Collet)

PARTS MT CONSUMABLES 70 / TORCH 75 / CABLES 57 / ADAPTER/DINSE 43-44 & 46



500 Amps

HR-24 or HR-32 pitch rack available on request.

BARREL MACHINE TORCHES

FRONT LOADING ONLY

The CKM230 and CKM350 torches come with a 1-3/8" (35mm) O.D. x 12" (30.5cm) high temperature phenolic resin handle as standard.

CKM230 | WATER COOLED | 300 AMP

HEAD STYLE	CABLE	CABLE LENGTH	STANDARD#	SUPER-FLEX#	SPECIFICATIONS
BARREL STYLE	3 Piece	12.5 ft. (3.8m)	CKM2312	CKM2312SF	14" (35.6cm) 6 oz (170gm) 1-3/8" (35mm) O.D. Barrel
	3 Piece	25 ft. (7.6m)	CKM2325	CKM2325SF	2 Series Head Accessories

PARTS CONSUMABLES 66 / TORCH 75 / CABLES 57 / ADAPTER/DINSE 43-44 & 46



300 Amps

HR-24 or HR-32 pitch rack available on request.

CKM350 | WATER COOLED | 400 AMP

HEAD STYLE	CABLE	CABLE LENGTH	STANDARD#	SUPER-FLEX#	SPECIFICATIONS
BARREL STYLE	3 Piece	12.5 ft. (3.8m)	CKM3512	CKM3512SF	15" (38.1cm) 6-1/4 oz (177gm) 1-3/8" (35mm) O.D. Barrel
	3 Piece	25 ft. (7.6m)	CKM3525	CKM3525SF	3 Series Head Accessories

PARTS CONSUMABLES 67-68 / TORCH 75 / CABLES 57 / ADAPTER/DINSE 43-44 & 46



400 Amps

HR-24 or HR-32 pitch rack available on request.

STEADY-GRIP™ & STEADY-GRIP™ FOOT PEDAL REMOTE AMPERAGE CONTROLS

CK Exclusive

With a removable or adjustable pistol-grip style handle the Steady-Grip™ gives the operator smooth, accurate, and ergonomic control over the TIG welding process. This full amperage control can be fitted to almost any machine and provides machine contactor ON/OFF and gas solenoid activation.

- ON/OFF
- Full amperage control
- Gas solenoid activation
- Ergonomic grip
- Adjustable / removable handle
- Trigger control



Torch not included

REMOVE HANDLE FOR USE AS LINEAR SLIDE CONFIGURATION



SEE PAGES 5 & 6 FOR INFORMATION



TRIGGER AMPERAGE CONTROL SELECTOR CHART

MACHINE MAKE POTENTIOMETER RATING	CONTROL TYPE	PLUG CONFIG & PIN COUNT	CONTROL CABLE LENGTH	HOOK AND LOOP STRAPS*	FOOT PEDAL VERSION*
				ONE SIZE FITS ALL	ONE SIZE FITS ALL
CK WORLDWIDE MT200-AC/DC 10K Ohm	Steady-Grip	5 Pin Plug	14 ft. (4.2 m)	SGACV-10-1-MT5	SGFP-10-1-MT5
			26.5 ft. (8.0 m)	SGACV-10-2-MT5	SGFP-10-2-MT5
			53 ft. (16.2 m)	SGACV-10-3-MT5	SGFP-10-3-MT5
LINCOLN ELECTRIC 10K Ohm	Steady-Grip	5 Pin Plug	14 ft. (4.2 m)	SGACV-10-1-L5	SGFP-10-1-L5
			26.5 ft. (8.0 m)	SGACV-10-2-L5	SGFP-10-2-L5
			53 ft. (16.2 m)	SGACV-10-3-L5	SGFP-10-3-L5
		6 Pin Plug	14 ft. (4.2 m)	SGACV-10-1-L6	SGFP-10-1-L6
			26.5 ft. (8.0 m)	SGACV-10-2-L6	SGFP-10-2-L6
			53 ft. (16.2 m)	SGACV-10-3-L6	SGFP-10-3-L6
MILLER ELECTRIC 1K Ohm	Steady-Grip	14 Pin Plug	14 ft. (4.2 m)	SGACV-1-1-M14	SGFP-1-1-M14
			26.5 ft. (8.0 m)	SGACV-1-2-M14	SGFP-1-2-M14
			53 ft. (16.2 m)	SGACV-1-3-M14	SGFP-1-3-M14
		5 Pin Plug	14 ft. (4.2 m)	SGACV-1-1-M5	SGFP-1-1-M5
			26.5 ft. (8.0 m)	SGACV-1-2-M5	SGFP-1-2-M5
			53 ft. (16.2 m)	SGACV-1-3-M5	SGFP-1-3-M5

CONTACT FACTORY FOR OTHER TIG MACHINES

*Hook and loop style is the only available style for Steady-Grip™



STEADY-GRIP FOOT PEDAL AMPERAGE CONTROL

This new foot pedal design provides maximum flexibility due to the integrated Steady-Grip pistol grip amperage control. Simply open up the foot pedal using two quick release bolts and extract the popular Steady-Grip pistol grip amperage control when needed. Attach your torch via the hook-and-loop straps and you're ready to weld!

AMPERAGE CONTROLS

STEADY-GRIP™



ROTARY AMPERAGE CONTROL

Remote amperage controls provide welding power source contactor on-off, activate gas and/or water solenoids, and provide full range current output control. Handle styles include hook and loop straps where one size fits all handle diameters and retrofits easily on all makes of torches or built into the handle as original equipment. A built in strain-relief prevents the control cord from being pulled out or damaged.

- Replace foot pedal amperage controls with fingertip operated amperage controls
- Hook and loop strap allows amperage control to quickly mount on any TIG torch or Stick electrode holder
- Amperage controls available as a complete handle assembly
- Fits most popular TIG machines
- Custom lengths available up to 200 ft. (61m)



BUILT-IN
(For CK torches)

Finger Guards

Hook and Loop Model

AMPERAGE
CONTROLS

ROTARY

ROTARY AMPERAGE CONTROL SELECTOR CHART

MACHINE MAKE POTENTIOMETER RATING	PLUG CONFIG & PIN COUNT	CONTROL CABLE LENGTH	HOOK AND LOOP STRAPS*	BUILT-IN HANDLE FOR CK TORCHES	
			ONE SIZE FITS ALL	SMALL CK9, CK17, CK20, CK24, CK24W, CK80, CK90, CK100, CK130, CK150, CKC150*, CK200, CKT200, FLEX-LOC*	MEDIUM CK230, CKA10, CKA20, TL18, TL26, TL210, TL300
CK WORLDWIDE MT200-AC/DC 10K Ohm	5 Pin Plug	14 ft. (4.2m)	RACCV-10-1-MT5	RAC2S-10-1-MT5	RAC2M-10-1-MT5
		26.5 ft. (8.0 m)	RACCV-10-2-MT5	RAC2S-10-2-MT5	RAC2M-10-2-MT5
		53 ft. (16.2 m)	RACCV-10-3-MT5	RAC2S-10-3-MT5	RAC2M-10-3-MT5
MILLER ELECTRIC 1K Ohm	14 Pin Plug	14 ft. (4.2m)	RACCV-1-1-M14	RAC2S-1-1-M14	RAC2M-1-1-M14
		26.5 ft. (8.0 m)	RACCV-1-2-M14	RAC2S-1-2-M14	RAC2M-1-2-M14
		53 ft. (16.2 m)	RACCV-1-3-M14	RAC2S-1-3-M14	RAC2M-1-3-M14
	5 Pin Plug	14 ft. (4.2m)	RACCV-1-1-M5	RAC2S-1-1-M5	RAC2M-1-1-M5
		26.5 ft. (8.0 m)	RACCV-1-2-M5	RAC2S-1-2-M5	RAC2M-1-2-M5
		53 ft. (16.2 m)	RACCV-1-3-M5	RAC2S-1-3-M5	RAC2M-1-3-M5
	6 Pin Plug	14 ft. (4.2m)	RACCV-1-1-M6	RAC2S-1-1-M6	RAC2M-1-1-M6
		26.5 ft. (8.0 m)	RACCV-1-2-M6	RAC2S-1-2-M6	RAC2M-1-2-M6
		53 ft. (16.2 m)	RACCV-1-3-M6	RAC2S-1-3-M6	RAC2M-1-3-M6
TWECO** 5K Ohm	14 Pin Plug	14 ft. (4.2m)	RACCV-5-1-TD14	RAC2S-5-1-TD14	RAC2M-5-1-TD14
		26.5 ft. (8.0 m)	RACCV-5-2-TD14	RAC2S-5-2-TD14	RAC2M-5-2-TD14
		53 ft. (16.2 m)	RACCV-5-3-TD14	RAC2S-5-3-TD14	RAC2M-5-3-TD14
	8 Pin Plug	14 ft. (4.2m)	RACCV-5-1-TD8	RAC2S-5-1-TD8	RAC2M-5-1-TD8
		26.5 ft. (8.0 m)	RACCV-5-2-TD8	RAC2S-5-2-TD8	RAC2M-5-2-TD8
		53 ft. (16.2 m)	RACCV-5-3-TD8	RAC2S-5-3-TD8	RAC2M-5-3-TD8
LINCOLN ELECTRIC 10K Ohm	14 Pin Plug	14 ft. (4.2m)	RACCV-10-1-L14	RAC2S-10-1-L14	RAC2M-10-1-L14
		26.5 ft. (8.0 m)	RACCV-10-2-L14	RAC2S-10-2-L14	RAC2M-10-2-L14
		53 ft. (16.2 m)	RACCV-10-3-L14	RAC2S-10-3-L14	RAC2M-10-3-L14
	5 Pin Plug	14 ft. (4.2m)	RACCV-10-1-L5	RAC2S-10-1-L5	RAC2M-10-1-L5
		26.5 ft. (8.0 m)	RACCV-10-2-L5	RAC2S-10-2-L5	RAC2M-10-2-L5
		53 ft. (16.2 m)	RACCV-10-3-L5	RAC2S-10-3-L5	RAC2M-10-3-L5
	6 Pin Plug	14 ft. (4.2m)	RACCV-10-1-L6	RAC2S-10-1-L6	RAC2M-10-1-L6
		26.5 ft. (8.0 m)	RACCV-10-2-L6	RAC2S-10-2-L6	RAC2M-10-2-L6
		53 ft. (16.2 m)	RACCV-10-3-L6	RAC2S-10-3-L6	RAC2M-10-3-L6

CONTACT FACTORY
FOR OTHER TIG
MACHINES

*Only Hook and Loop Style
will fit Valved CKC150s
and Valved Flex-Locs

**Tweco 186 AC/DC
not available

LINEAR AMPERAGE CONTROL

The Amptrak™ remote current control provides remote on-off control of the welding power source contactor and/or gas and water solenoid control, as well as full range remote current output control. A built in strain-relief prevents the control cord from being pulled out or damaged. The Amptrak™ remote current control can be ordered either built into a CK torch handle as original equipment or in the hook and loop model where one size fits all.

- Linear slide actuator for complete ON/OFF and full amperage control
- Built in handle or hook and loop strap design to fit all TIG torches
- Adapts to most standard TIG power sources
- Protected against high frequency

BUILT-IN
(For CK torches)

Hook and Loop Model



LINEAR AMPERAGE CONTROL SELECTOR CHART

MACHINE MAKE POTENTIOMETER RATING	PLUG CONFIG & PIN COUNT	CONTROL CABLE LENGTH	HOOK & LOOP STRAPS*		BUILT-IN HANDLE FOR CK TORCHES		
			ONE SIZE FITS ALL	SMALL CK9, CK7, CK20, CK24, CK24W, CK80, CK90, CK100, CK130, CK150, CKC150*, CK200, CKT200, FLEX-LOC*	MEDIUM CK230, CKA10, CKA20, TL18, TL26, TL210, TL300	LARGE CK18, CK26, CK210, CK300, CK350, CK510	
CK WORLDWIDE MT200-AC/DC 10K Ohm	5 Pin Plug	14 ft. (4.2m)	AMTCV-10-1-MT5	AMT2S-10-1-MT5	AMT2M-10-1-MT5	AMT2L-10-1-MT5	
		26.5 ft. (8.0 m)	AMTCV-10-2-MT5	AMT2S-10-2-MT5	AMT2M-10-2-MT5	AMT2L-10-2-MT5	
		53 ft. (16.2 m)	AMTCV-10-3-MT5	AMT2S-10-3-MT5	AMT2M-10-3-MT5	AMT2L-10-3-MT5	
MILLER ELECTRIC 1K Ohm	14 Pin Plug	14 ft. (4.2m)	AMTCV-1-1-M14	AMT2S-1-1-M14	AMT2M-1-1-M14	AMT2L-1-1-M14	
		26.5 ft. (8.0 m)	AMTCV-1-2-M14	AMT2S-1-2-M14	AMT2M-1-2-M14	AMT2L-1-2-M14	
		53 ft. (16.2 m)	AMTCV-1-3-M14	AMT2S-1-3-M14	AMT2M-1-3-M14	AMT2L-1-3-M14	
	5 Pin Plug	14 ft. (4.2m)	AMTCV-1-1-M5	AMT2S-1-1-M5	AMT2M-1-1-M5	AMT2L-1-1-M5	
		26.5 ft. (8.0 m)	AMTCV-1-2-M5	AMT2S-1-2-M5	AMT2M-1-2-M5	AMT2L-1-2-M5	
		53 ft. (16.2 m)	AMTCV-1-3-M5	AMT2S-1-3-M5	AMT2M-1-3-M5	AMT2L-1-3-M5	
	6 Pin Plug	14 ft. (4.2m)	AMTCV-1-1-M6	AMT2S-1-1-M6	AMT2M-1-1-M6	AMT2L-1-1-M6	
		26.5 ft. (8.0 m)	AMTCV-1-2-M6	AMT2S-1-2-M6	AMT2M-1-2-M6	AMT2L-1-2-M6	
		53 ft. (16.2 m)	AMTCV-1-3-M6	AMT2S-1-3-M6	AMT2M-1-3-M6	AMT2L-1-3-M6	
TWECO** 5K Ohm	14 Pin Plug	14 ft. (4.2m)	AMTCV-5-1-TD14	AMT2S-5-1-TD14	AMT2M-5-1-TD14	AMT2L-5-1-TD14	
		26.5 ft. (8.0 m)	AMTCV-5-2-TD14	AMT2S-5-2-TD14	AMT2M-5-2-TD14	AMT2L-5-2-TD14	
		53 ft. (16.2 m)	AMTCV-5-3-TD14	AMT2S-5-3-TD14	AMT2M-5-3-TD14	AMT2L-5-3-TD14	
	8 Pin Plug	14 ft. (4.2m)	AMTCV-5-1-TD8	AMT2S-5-1-TD8	AMT2M-5-1-TD8	AMT2L-5-1-TD8	
		26.5 ft. (8.0 m)	AMTCV-5-2-TD8	AMT2S-5-2-TD8	AMT2M-5-2-TD8	AMT2L-5-2-TD8	
		53 ft. (16.2 m)	AMTCV-5-3-TD8	AMT2S-5-3-TD8	AMT2M-5-3-TD8	AMT2L-5-3-TD8	
LINCOLN ELECTRIC 10K Ohm	14 Pin Plug	14 ft. (4.2m)	AMTCV-10-1-L14	AMT2S-10-1-L14	AMT2M-10-1-L14	AMT2L-10-1-L14	
		26.5 ft. (8.0 m)	AMTCV-10-2-L14	AMT2S-10-2-L14	AMT2M-10-2-L14	AMT2L-10-2-L14	
		53 ft. (16.2 m)	AMTCV-10-3-L14	AMT2S-10-3-L14	AMT2M-10-3-L14	AMT2L-10-3-L14	
	5 Pin Plug	14 ft. (4.2m)	AMTCV-10-1-L5	AMT2S-10-1-L5	AMT2M-10-1-L5	AMT2L-10-1-L5	
		26.5 ft. (8.0 m)	AMTCV-10-2-L5	AMT2S-10-2-L5	AMT2M-10-2-L5	AMT2L-10-2-L5	
		53 ft. (16.2 m)	AMTCV-10-3-L5	AMT2S-10-3-L5	AMT2M-10-3-L5	AMT2L-10-3-L5	
	6 Pin Plug	14 ft. (4.2m)	AMTCV-10-1-L6	AMT2S-10-1-L6	AMT2M-10-1-L6	AMT2L-10-1-L6	
		26.5 ft. (8.0 m)	AMTCV-10-2-L6	AMT2S-10-2-L6	AMT2M-10-2-L6	AMT2L-10-2-L6	
		53 ft. (16.2 m)	AMTCV-10-3-L6	AMT2S-10-3-L6	AMT2M-10-3-L6	AMT2L-10-3-L6	

CONTACT FACTORY FOR OTHER TIG MACHINES

*Only Hook and Loop Style will fit Valved CKC150s and Valved Flex-Locs

**Tweco 186 AC/DC not available

TOLL FREE: (800) 426.0877 | www.CKWORLDWIDE.com

WHEEL AMPERAGE CONTROL

Remote amperage controls provide welding power source contactor ON/OFF, activate gas and/or water solenoids, and provide full range current output control. Handle style includes hook and loop straps where one size fits all handle diameters and retrofits easily on all makes of TIG torches.

- Returns to off automatically
- Insures electrode not "hot" when not in use
- Great for tack welding, short or long welds, and "bumping" technique
- Can be positioned closer to torch head for optimum torch control



AMPERAGE CONTROLS

WHEEL

WHEEL AMPERAGE CONTROL SELECTOR CHART

MACHINE MAKE POTENTIOMETER RATING	PLUG CONFIG & PIN COUNT	CONTROL CABLE LENGTH	HOOK AND LOOP STRAPS*
			ONE SIZE FITS ALL
CK WORLDWIDE MT200-AC/DC 10K Ohm	5 Pin Plug	14 ft. (4.2m)	WACCV-10-1-MT5
		26.5 ft. (8.0 m)	WACCV-10-2-MT5
		53 ft. (16.2 m)	WACCV-10-3-MT5
MILLER ELECTRIC 1K Ohm	14 Pin Plug	14 ft. (4.2m)	WACCV-1-1-M14
		26.5 ft. (8.0 m)	WACCV-1-2-M14
		53 ft. (16.2 m)	WACCV-1-3-M14
	5 Pin Plug	14 ft. (4.2m)	WACCV-1-1-M5
		26.5 ft. (8.0 m)	WACCV-1-2-M5
		53 ft. (16.2 m)	WACCV-1-3-M5
	6 Pin Plug	14 ft. (4.2m)	WACCV-1-1-M6
		26.5 ft. (8.0 m)	WACCV-1-2-M6
		53 ft. (16.2 m)	WACCV-1-3-M6
TWECO* 5K Ohm	14 Pin Plug	14 ft. (4.2m)	WACCV-5-1-TD14
		26.5 ft. (8.0 m)	WACCV-5-2-TD14
		53 ft. (16.2 m)	WACCV-5-3-TD14
	8 Pin Plug	14 ft. (4.2m)	WACCV-5-1-TD8
		26.5 ft. (8.0 m)	WACCV-5-2-TD8
		53 ft. (16.2 m)	WACCV-5-3-TD8
LINCOLN ELECTRIC 10K Ohm	14 Pin Plug	14 ft. (4.2m)	WACCV-10-1-L14
		26.5 ft. (8.0 m)	WACCV-10-2-L14
		53 ft. (16.2 m)	WACCV-10-3-L14
	5 Pin Plug	14 ft. (4.2m)	WACCV-10-1-L5
		26.5 ft. (8.0 m)	WACCV-10-2-L5
		53 ft. (16.2 m)	WACCV-10-3-L5
	6 Pin Plug	14 ft. (4.2m)	WACCV-10-1-L6
		26.5 ft. (8.0 m)	WACCV-10-2-L6
		53 ft. (16.2 m)	WACCV-10-3-L6

CONTACT FACTORY
FOR OTHER TIG
MACHINES

*Tweco 186 AC/DC
not available

REMOTE CONTACTOR CONTROL/ ELECTRIC SWITCH

- Locking switch
- Momentary switch
- TIG power source contactor on/off
- Good for 2T / 4T applications

ELECTRIC SWITCHES LOCKING | MOMENTARY

Electric Switch Clipper Hook and Loop Models*

SWITCH TYPE	CABLE LENGTH	ONE SIZE FITS ALL / ORDER #
LOCKING SW2	14 ft. (4.3m)	ESLCV12
	26.5 ft. (8m)	ESLCV25
MOMENTARY SW3	14 ft. (4.3m)	ESCV12
	26.5 ft. (8m)	ESCV25

*Built-in handle options available, please contact CK Worldwide for part numbers.

DOES NOT INCLUDE AMPHENOL PLUG, PLEASE CONTACT US OR CONSULT YOUR DISTRIBUTOR FOR THE CORRECT PART NUMBER FOR YOUR WELDING MACHINE



SW2
Locking Switch



SW3
Momentary Switch

ELECTRIC SWITCHES

SW2 LOCKING SWITCH COMPONENTS

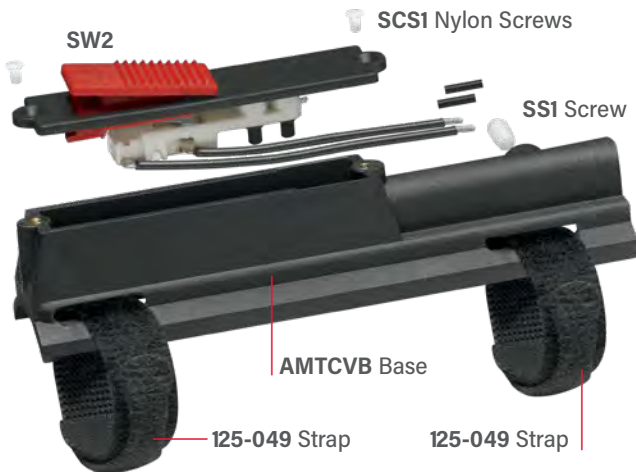

TO REPLACE **SW2** ELECTRIC SWITCH:

1. Carefully solder the control wires to the switch leads and insulate the connection with heat shrink tubing or tape. Make sure that final diameter is not too great to fit inside the control wire housing.
2. For best results, ease the switch into the rear part of the handle cavity first (a small screwdriver is useful in easing the lead wires into the cavity). Then, gently push the switch forward and down into the proper position and secure it with the switch screws.
3. Secure the control wire with the nylon set screw at the rear of the handle.

SW3 MOMENTARY SWITCH COMPONENTS

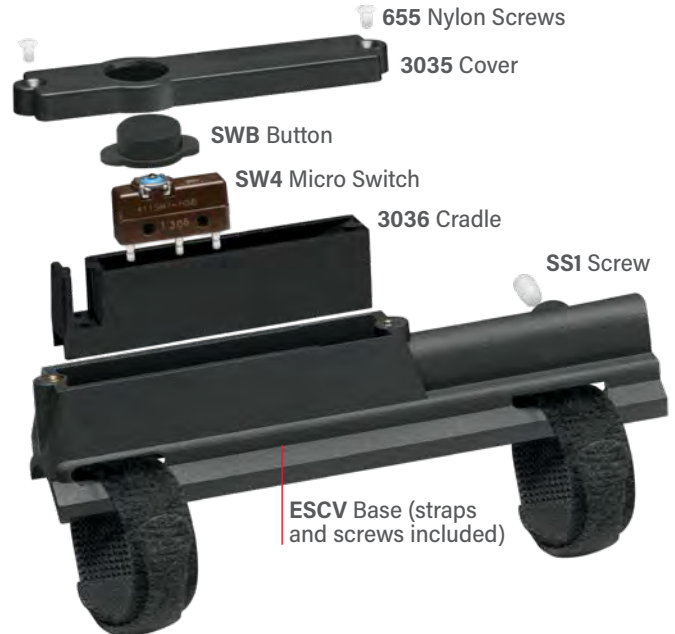

TO REPLACE **SW4** PLUG-IN SWITCH:

1. Remove the nylon switch cover screws, switch cover and switch button.
2. Unplug the inoperative micro switch and plug in a new micro switch.
3. Re-assemble the switch and switch cover over the new micro switch and secure the cover to the handle with the nylon switch screws.

CAUTION: DO NOT OVERTIGHTEN THE NYLON SCREWS.

DINSE 25 / DINSE 35

These are the industry standard Dinse 25 and Dinse 35 SAFE-LOC adapters used to connect TIG torches to your welding machine dependent on its functionality and the torch you are using.

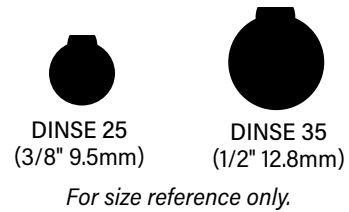

These connectors are for non gas-thru Dinse style machines. For assistance in ordering the proper connector please call or email our customer service team at (800) 426.0877 or Help@CKWorldwide.com.

DINSE 25 | GAS COOLED 3/8-INCH | 9.5MM

TORCHES	ORDER #
CK24, 80, 90, 100	SL2-25-24
CK9, 17, 130, 150, FL130, FL150, MR70	SL2-25
MT100, CKC150, CK210, TL210, CKA16	SL5-25
CK26, TL26	SL8-25

DINSE 35 | GAS COOLED 1/2-INCH | 12.8MM

TORCHES	ORDER #
CK24, 80, 90, 100	SL2-35-24
CK9, 17, 130, 150, FL130, FL150, MR70	SL2-35
MT100, CKC150, CK210, TL210, CKA16	SL5-35
CK26, TL26	SL8-35

For a quick disconnect installed on your argon/gas line add "QD" to the end of the dinse part number.

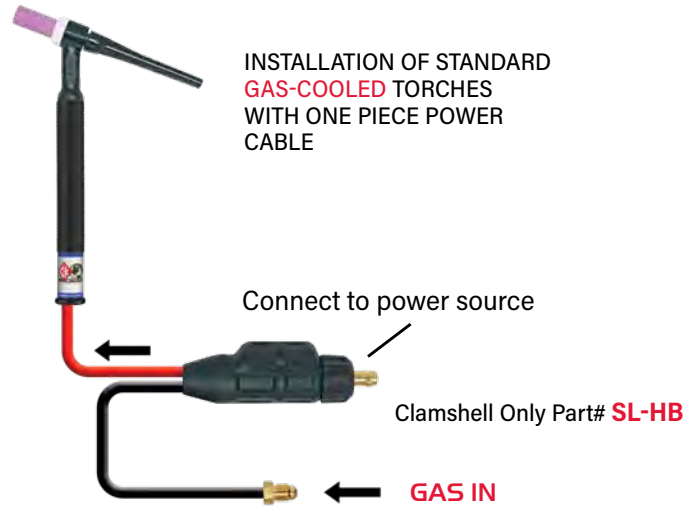

DINSE 25 | WATER COOLED 3/8-INCH | 9.5MM

TORCHES	ORDER #
CK18, 20, 24W, 25, 180, 200, TL18	SLWHAT-25
CKT200, CK230, CK300, TL300	
CK510, CK24W, CKM230, CKM350, FL230, FL250	
MR140, MT400, MT500	

DINSE 35 | WATER COOLED 1/2-INCH | 12.8MM

TORCHES	ORDER #
CK18, 20, 24W, 25, 180, 200, TL18	SLWHAT-35
CKT200, CK230, CK300, TL300	
CK510, CK24W, CKM230, CKM350, FL230, FL250	
MR140, MT400, MT500	

For a quick disconnect installed on your water lines add "QD" to the end of the dinse part number.

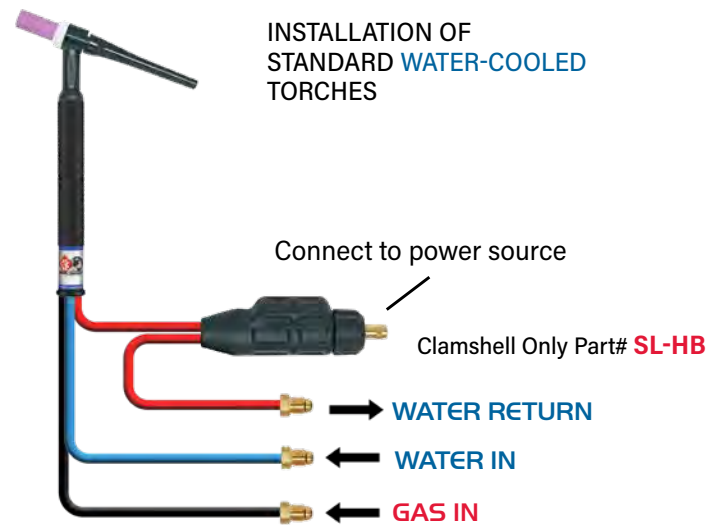

Scan to see our
Dinse/Amphenol
selector list online

DINSE 25M / 35M

These are the industry standard gas-thru Dinse 25 and Dinse 35 SAFE-LOC adapters used to connect TIG torches to your welding machine dependent on its functionality and the torch you are using.

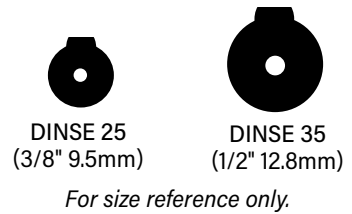

These connectors are for gas-thru Dinse style machines. For assistance in ordering the proper connector please call or email our customer service team at (800) 426.0877 or Help@CKWorldwide.com.

DINSE 25M | GAS COOLED 3/8-INCH | 9.5MM

TORCHES	ORDER #
CK24, 80, 90, 100	SL2-25M-24
CK9, 17, 130, 150, FL130, FL150, MR70	SL2-25M
MT100, CKC150, CK210, TL210, CKA16	SL5-25M
CK26, TL26	SL8-25M

DINSE 35M | GAS COOLED 1/2-INCH | 12.8MM

TORCHES	ORDER #
CK24, 80, 90, 100	SL2-35M-24
CK9, 17, 130, 150, FL130, FL150, MR70	SL2-35M
MT100, CKC150, CK210, TL210, CKA16	SL5-35M
CK26, TL26	SL8-35M

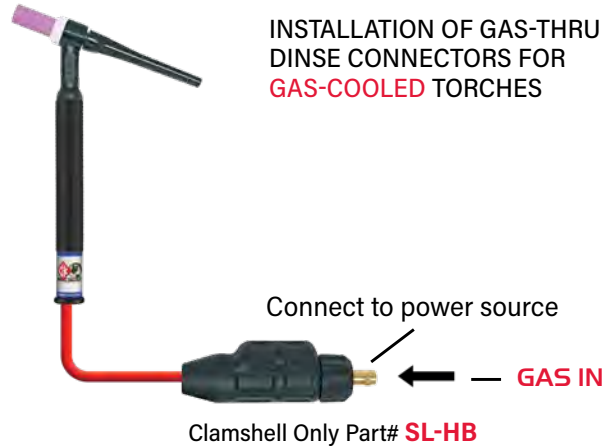

DINSE 25M | WATER COOLED 3/8-INCH | 9.5MM

TORCHES	ORDER #
CK18, 20, 24W, 25, 180, 200, TL18	SLWHAT-25M
CKT200, CK230, CK300, TL300	
CK510, CK24W, CKM230, CKM350, FL230, FL250	
MR140, MT400, MT500	

DINSE 35M | WATER COOLED 1/2-INCH | 12.8MM

TORCHES	ORDER #
CK18, 20, 24W, 25, 180, 200, TL18	SLWHAT-35M
CKT200, CK230, CK300, TL300	
CK510, CK24W, CKM230, CKM350, FL230, FL250	
MR140, MT400, MT500	

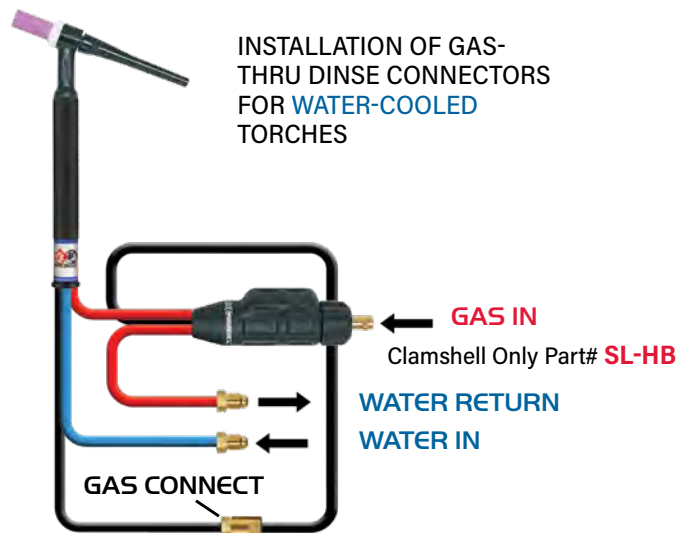

For a quick disconnect installed on your water lines add "QD" to the end of the dinse part number.



TWECO/CAM-LOCK SAFE-LOC®

These are the industry standard TWECO / CAM-LOCK SAFE-LOC adapters used to connect TIG torches to your welding machine dependent on its functionality and the torch you are using.

These connectors are for non gas-thru Tweco/Cam-Lock style machines. For assistance in ordering the proper connector please call or email our customer service team at (800) 426.0877 or Help@CKWorldwide.com.

TWECO | GAS COOLED (2MPC-Male)

TORCHES	ORDER #
CK24, 80, 90, 100	SL2-2-24
CK9, 17, 130, 150, FL130, FL150, MR70	SL-2
MT100, CKC150, CK210, TL210, CKA16	SL-5
CK26, TL26	SL-8

CAM-LOCK | GAS COOLED

TORCHES	ORDER #
CK24, 80, 90, 100	SL2-CL-24
CK9, 17, 130, 150, FL130, FL150, MR70	SL2-CL
MT100, CKC150, CK210, TL210, CKA16	SL5-CL
CK26, TL26	SL8-CL

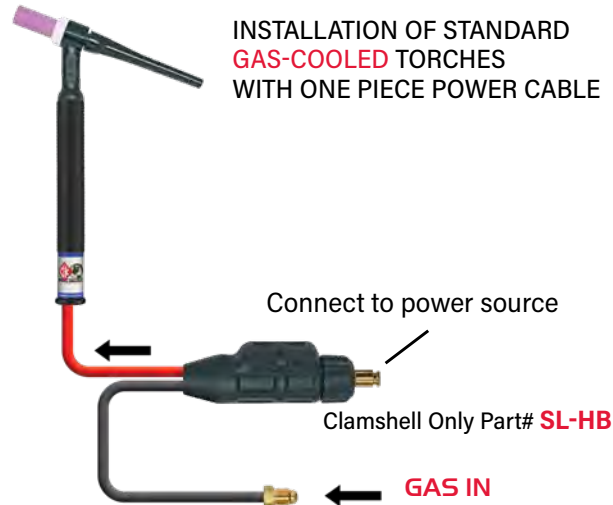

TWECO | WATER COOLED (2MPC-Male)

TORCHES	ORDER #
CK18, 20, 24W, 25, 180, 200, TL18	SLWHAT-T
CKT200, CK230, CK300, TL300	
CK510, CK24W, CKM230, CKM350, FL230, FL250	
MR140, MT300, MT400, MT500	

CAM-LOCK | WATER COOLED

TORCHES	ORDER #
CK18, 20, 24W, 25, 180, 200, TL18	SLWHAT-CL
CKT200, CK230, CK300, TL300	
CK510, CK24W, CKM230, CKM350, FL230, FL250	
MR140, MT300, MT400, MT500	

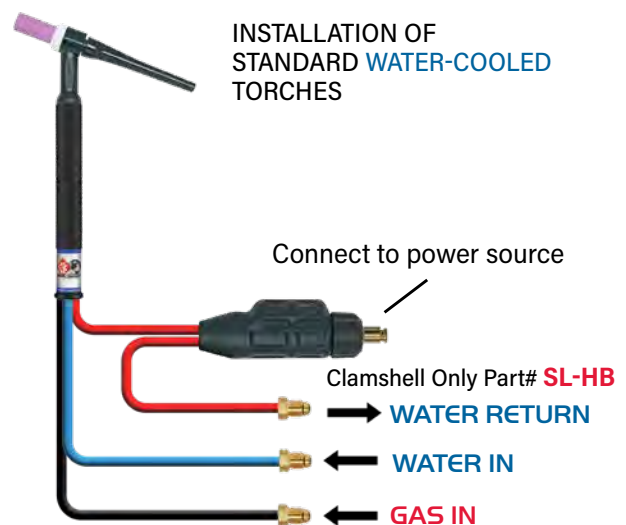

Scan to see our
Dinse/Amphenol
selector list online

QUICK-DISCONNECT CABLE ADAPTERS

These adapters are for gas-cooled and water-cooled torch setups that have quick-disconnect female adapters on either the machine or water-cooler.

QDGAP | GAS COOLED

9mm male quick disconnect for argon.
Female 5/8" x 18 right hand threads to 9mm male spud.



QDWAP | WATER COOLED

9mm male quick disconnect for water.
Female 5/8" x 18 left hand threads to 9mm male spud.



POWER CABLE ADAPTERS

These adapters are for connecting TIG torches to machines with stud/lug-nut/bolt-on type connectors versus the DINSE or TWECO/CAM-LOCK SAFE-LOC style connectors. Refer to the charts below to find for the proper connector to match your torch setup.

Note: These connectors are for lug connector style machines—if you have any questions regarding which connector to purchase please call or email us for help.

GAS COOLED ADAPTERS

1PCA | 53N43



3/8" x 24 5/8" x 18 RH

Used with:
CK24, CK80,
CK90, CK100

45V62



7/8"-14 RH 5/8" x 18 RH

Used with:
CK26, TL26

15PCA | 105Z57



3/8" x 24 5/8" x 18 RH

Used with:
CK9, CK17, CK130,
CK150, FL130, FL150,

21HPCA | 2310-1879



5/8" x 18 RH 5/8" x 18

Used with:
CKC150, CK210, TL210,
MT100, CKA16

APCA10 | 2310-2101



7/16" x 20 RH 5/8" x 18 RH

Used with:
CKA10

WATER COOLED ADAPTERS

APCA35 | 2310-0375



5/8" x 18 LH 5/8" x 18 LH

Used with:
CKA35

APCA20 | 2310-1824



3/8" x 24 5/8" x 18 LH

Used with:
CKA20

2PCA | 45V11



7/8" x 14 LH 5/8" x 18 LH

Used with: CK18, CK20, CK24W,
CK25, CK180, CK200, CK230,
CK300, CK510, TL18, TL300, FL230,
FL250, MR140, MT400, MT500

CABLE EXTENSIONS (DINSE / TWECO SAFE-LOC)

Below are DINSE 35M and TWECO SAFE-LOC cable extensions used to increase the active length of your welding lead(s) for gas-cooled or water-cooled torches.

GCKD-25-35M KIT | GAS COOLED

Used for Gas-Cooled Torches. GCKD-25-35M consists of:

- One 25 foot (7.6m) power and gas extension with 35 Dinse Gas-Thru connectors

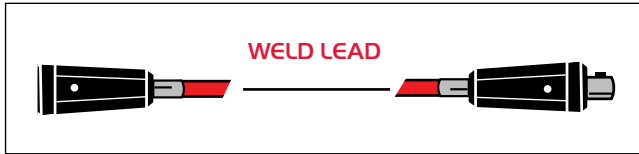

GCKD-25-35 KIT | GAS COOLED

Used for Gas-Cooled Torches, single piece or two piece cable assemblies. GCKD-25-35 consists of:

- One 25 foot (7.6m) #2 AWG weld lead power cable with female Tweco connector on the torch end, and a 35 Dinse Non Gas-Thru Connection on the machine end
- One argon hose extension (Part # 40V77L)
- One argon hose coupler

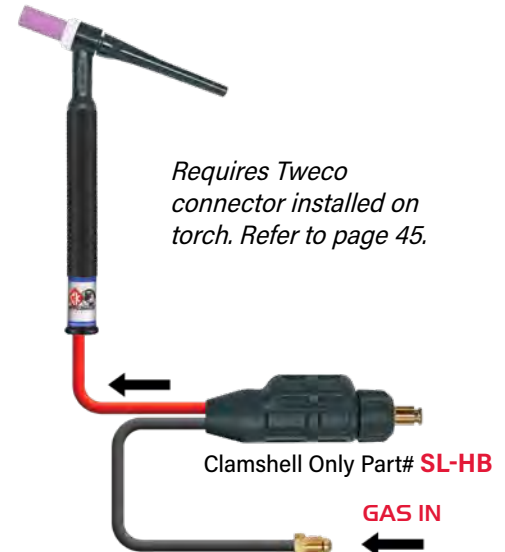
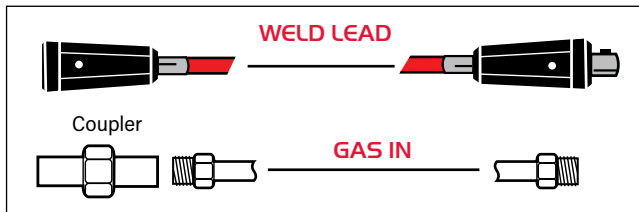

WCK-25-35 KIT | WATER COOLED

Used for Water-Cooled Torches. WCK-25-35 kit consists of:

- One 25 foot (7.6m) #2 AWG weld lead power cable with female Tweco connector on the torch end, and a 35 Dinse Non Gas-Thru Connection on the machine end
- One argon hose extension (Part # 40V77L)
- One argon hose coupler (Part # 3026)
- Two water hose extensions (Part # 40V76L)

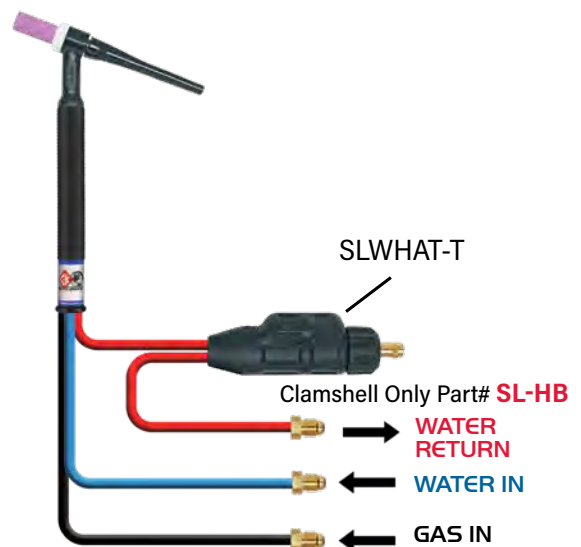
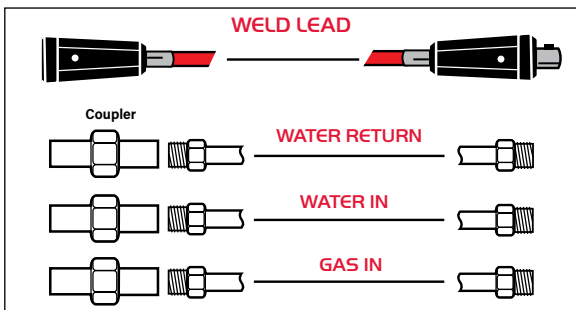

CABLE EXTENSIONS

Below are standard cable extensions used to increase the active length of your welding lead(s) for gas-cooled or water-cooled torches.

EK-2-25 | GAS COOLED

EK-2-25 kit includes:

- One power cable 25' (7.6m)
Part #57Y03R
- One power cable (Part # 150CE),
coupler (Part # 2654) and insulator



EK-1-25 | WATER COOLED

EK-1-25 kit includes:

- One 25' (7.6m) power cable (Part # 40V78LR)
- One 25' (7.6m) extension Water Hose (Part # 40V76L)
- One 25' (7.6m) extension gas hose (Part # 40V77L)
- One power cable coupler (Part # 2678)
and insulator (Part # 2677)
- One water hose coupler (Part # 3027)
- One gas hose coupler (Part # 3026)



LEATHER HOSE COVERS *CK EXCLUSIVE*

These durable leather protective hose covers are abrasion, heat, flame, UV and oil resistant.



- Easy hook and loop opening and closing
- Lightweight, supple, remains flexible in all climates
- No more damaged zippers or snaps

LEATHER HOSE COVERS

TORCHES	LENGTH*	WIDTH	INSIDE DIAMETER	ORDER#
CK9, CK17, CK20	10 ft. (3.0m)	3-3/4" (95mm)	1" (25mm)	212HCLV
	22 ft. (7.0m)	3-3/4" (95mm)	1" (25mm)	225HCLV
CK18, CK26	10 ft. (3.0m)	4-1/2" (114mm)	1-1/4" (31mm)	312HCLV
	22 ft. (7.0m)	4-1/2" (114mm)	1-1/4" (31mm)	325HCLV

ZIPPER NYLON HOSE COVERS

Durable woven nylon with zipper fasteners.

- Abrasion resistant
- UV resistant
- Lightweight
- Zipper fastener

NYLON ZIPPER HOSE COVERS

USE WITH	LENGTH*	WIDTH	INSIDE DIAMETER	ORDER#
CK9, CK17, CK20	10 ft. (3.0m)	3" (76mm)	1" (25mm)	CC-3-10
	22 ft. (7.0m)	3" (76mm)	1" (25mm)	CC-3-22
CK18, CK26	10 ft. (3.0m)	4" (101mm)	1-1/4" (31mm)	CC-4-10
	22 ft. (7.0m)	4" (101mm)	1-1/4" (31mm)	CC-4-22



CK WORLDWIDE SCHOLARSHIP

CK Worldwide, in collaboration with the AWS Foundation, annually awards the Art Kleppen Family — CK Worldwide Scholarships, providing two \$2,500 scholarships to students seeking an Associate's Degree in welding, focusing on TIG Welding (GTAW). This initiative reflects CK Worldwide's commitment to the welding community, supporting the educational and professional growth of future welders by funding tuition and essential equipment.

Beyond its scholarship program, CK Worldwide is committed to supporting welding education by offering educational discounts through their distributors. These discounts aim to alleviate the financial burden on colleges, vocational schools, and union training programs, making high-quality TIG welding equipment more accessible for both educators and students. By providing these discounts, CK Worldwide enhances the educational experience in TIG welding, ensuring that future welding professionals have the tools they need for success while reinforcing the company's dedication to the advancement of the welding industry.

To learn more about the Art Kleppen Family Scholarship please visit:
www.AWS.org/Career-Resources/Students/Scholarships/National-Scholarships/



Washington State University, "Wazzu" racing team using a CK torch and machine to work on parts for their car.



Scan for more information about scholarships and CK education programs

SCHOLARSHIP & RESOURCES

TECHNICAL RESOURCES

CK Worldwide, as the standard in TIG welding offers a variety of technical resources online at www.CKWorldwide.com under the Literature section you will find downloadable versions of:

- Torch Manuals for 2 Series (Standard + MasterTIG), 3 Series (Standard + MasterTIG), and 8 Series
- CK's Solution Guide (Form 3010)
- Product flyers
- CK's Technical Guide (Form 116)
An in-depth technical guide with detailed information on
 - Torch connection diagrams
 - Characteristics of current types
 - Shield gas selection and use
 - Tungsten selection and preparation
 - Characteristics of current types
 - Detailed welding parameters for aluminum, titanium, magnesium, deoxidized copper, stainless steel and low alloy steel



CUSTOM-SIZED | PATENTED CK EXCLUSIVE PURGE CHAMBER

The patented CK Flexible Purge Chamber is used in the Tungsten Inert Gas (TIG) process to provide a completely inert atmosphere for the welding of reactive metals such as titanium, molybdenum, nickel-based and aluminum-based alloys, as well as non-reactive metals like stainless steel. Unique to this design is the ability to draw a vacuum around the product to be welded by collapsing the chamber. The chamber is then filled through a perforated hose that encircles the bottom of the chamber allowing the argon gas to expel all atmospheric gases more effectively through the top valve port. This significantly reduces the time required to reach an inert atmosphere suitable for welding, while using considerably less gas than traditional rigid purge chambers.

ORDER # **PC2000-24**

BENEFITS

- Less argon required
- Collapsible, easily stored
- Multiple accessory & glove ports
- Less expensive
- Less time to fill
- Vacuum drawn
- Facilitates welding grade atmosphere
- 30" (76.8cm) diameter



*Contact CK Worldwide for price and availability on other sizes.

SPECIFICATIONS

HEIGHT	20" (51.2cm)
WIDTH	30" (76.8cm)*
SHIPPING WEIGHT	47 lbs. (21.3kg)
ZIPPER LENGTH	60" (153.6cm)
STANDARD SIZE	30" (76.8cm) diameter
	24" (61.4cm) base

Custom-designed chambers
are also available - ANY SIZE

INCLUDED PARTS:

- 115V Vacuum pump (220V also available)
- Dual flowmeter/regulator
- 2 Work stations
- 2 Sets of gloves
- 4 Accessory ports
- Heat blanket
- 10 ft. (3m) Argon hose
- 10 ft. (3m) Vacuum hose
- Repair kit
- Storage container





CK's exclusive Super-Flex cables increase range of motion, reduce fatigue and improve productivity.

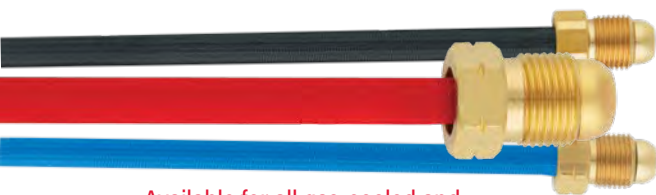

Available for all gas-cooled and water-cooled torches

SUPER-FLEX™ CABLES

CK EXCLUSIVE

Innovative design replaces heavy, stiff cables to increase range of motion, reducing fatigue and improving productivity.

- Lightweight silicon rubber with durable nylon overbraid protection
- Stays flexible in harsh weather conditions



Efficient Tri-Flex cables streamline your cabling

TRI-FLEX CABLES

CK EXCLUSIVE

CK Worldwide Tri-Flex cables are bonded vinyl hoses allowing for easy movement and no tangles when welding with water-cooled torches. These cables resist dirt and streamline your cabling for efficient work in the shop or in the field.



Un-bonded vinyl cables—the traditional choice for TIG welding

3-PIECE VINYL CABLES

The 3-Piece cables we offer are the same as the Tri-Flex cables except they are un-bonded. These cables are what most TIG welders are familiar with, and know from experience in the industry.



Rubber hose with internal braiding for durability

RUBBER HOSE

Our rubber hoses are the industry standard for gas-cooled torches and feature internal braiding for increased strength and durability.

CK9, CK17, CK130, CK150, CKM150, MR70 GAS COOLED

1 PIECE STANDARD POWER CABLE



1 PIECE SUPER-FLEX POWER CABLE



2 PIECE STANDARD POWER CABLE



2 PIECE SUPER-FLEX POWER CABLE



LENGTH	STANDARD	SUPER-FLEX
	1 PIECE CABLE	1 PIECE CABLE
12-1/2 ft. (3.8m)	1512PCHF (57Y01R)	1512PCSF (57Y01RSF)
25 ft. (7.6m)	1525PCHF (57Y03R)	1525PCSF (57Y03RSF)
LENGTH	2 PIECE CABLES	2 PIECE CABLES
	1512PCN	1512PCNSF
12-1/2 ft. (3.8m)	1512PCN (57Y01-2)	1512PCNSF (57Y01-2SF)
25 ft. (7.6m)	1525PCN (57Y03-2)	1525PCNSF (57Y03-2SF)
LENGTH	WELD LEAD	
	1512CN	
12-1/2 ft. (3.8m)	1512CN	
25 ft. (7.6m)	1525CN	
LENGTH	ARGON HOSE	ARGON HOSE
	212AH	212AHSF
12-1/2 ft. (3.8m)	212AH (45V09)	212AHSF (45V09SF)
25 ft. (7.6m)	225AH (45V10)	225AHSF (45V10SF)

CK24, CK80, CK90, CK100 GAS COOLED

1 PIECE STANDARD POWER CABLE



1 PIECE SUPER-FLEX POWER CABLE



2 PIECE STANDARD POWER CABLE



2 PIECE SUPER-FLEX POWER CABLE



LENGTH	STANDARD	SUPER-FLEX
	1 PIECE CABLE	1 PIECE CABLE
12-1/2 ft. (3.8m)	112PCHF (56Y38R)	112PCSF (56Y38RSF)
25 ft. (7.6m)	125PCHF (56Y97R)	125PCSF (56Y97RSF)
LENGTH	2 PIECE CABLES	2 PIECE CABLES
	112PCN	112PCNSF
12-1/2 ft. (3.8m)	112PCN (56Y38-2)	112PCNSF (56Y38-2SF)
25 ft. (7.6m)	125PCN (56Y97-2)	125PCNSF (56Y97-2SF)
LENGTH	WELD LEAD	
	112CN	
12-1/2 ft. (3.8m)	112CN	
25 ft. (7.6m)	125CN	
LENGTH	ARGON HOSE	ARGON HOSE
	212AH	212AHSF
12-1/2 ft. (3.8m)	212AH (45V09)	212AHSF (45V09SF)
25 ft. (7.6m)	225AH (45V10)	225AHSF (45V10SF)

CK26, TL26, CK210, TL210, CKM210 GAS COOLED

1 PIECE STANDARD POWER CABLE CK26/TL26



1 PIECE SUPER-FLEX POWER CABLE CK26/TL26



2 PIECE STANDARD POWER CABLE



2 PIECE SUPER-FLEX POWER CABLE



LENGTH	7/8" STANDARD	7/8" SUPER-FLEX
	1 PIECE CABLE	1 PIECE CABLE
12-1/2 ft. (3.8m)	46V28R	46V28RSF
25 ft. (7.6m)	46V30R	46V30RSF
LENGTH	2 PIECE CABLES	2 PIECE CABLES
	412PCN	412PCNSF
12-1/2 ft. (3.8m)	412PCN (46V28-2)	412PCNSF (46V28-2SF)
25 ft. (7.6m)	425PCN (46V30-2)	425PCNSF (46V30-2SF)
LENGTH	WELD LEAD	
	412CN	
12-1/2 ft. (3.8m)	412CN	
25 ft. (7.6m)	425CN	
LENGTH	ARGON HOSE	ARGON HOSE
	312AH	312AHSF
12-1/2 ft. (3.8m)	312AH (40V75)	312AHSF (40V75SF)
25 ft. (7.6m)	325AH (41V30)	325AHSF (41V30SF)

1 PIECE STANDARD POWER CABLE CK210/TL210/CKM210



1 PIECE SUPER-FLEX POWER CABLE CK210/TL210/CKM210



LENGTH	5/8" STANDARD	5/8" SUPER-FLEX
	1 PIECE CABLE	1 PIECE CABLE
12-1/2 ft. (3.8m)	412PCHF	412PCSF
25 ft. (7.6m)	425PCHF	425PCSF

CK26HD GAS COOLED

2 PIECE SUPER-FLEX POWER CABLE



LENGTH	STANDARD	SUPER-FLEX
	2 PIECE CABLES	2 PIECE CABLES
12-1/2 ft. (3.8m)	---	412PCNSFHD
25 ft. (7.6m)	---	425PCNSFHD
LENGTH	WELD LEAD	
12-1/2 ft. (3.8m)	412CNHD	
25 ft. (7.6m)	425CNHD	
LENGTH	ARGON HOSE	ARGON HOSE
12-1/2 ft. (3.8m)	---	312AHSF
25 ft. (7.6m)	---	325AHSF

TWECO SETUP

LENGTH	STANDARD	SUPER-FLEX
	2 PIECE CABLES	2 PIECE CABLES
12-1/2 ft. (3.8m)	---	412PCNSFHDT
25 ft. (7.6m)	---	425PCNSFHDT
LENGTH	WELD LEAD	
12-1/2 ft. (3.8m)	412CNHDT	
25 ft. (7.6m)	425CNHDT	
LENGTH	ARGON HOSE	ARGON HOSE
12-1/2 ft. (3.8m)	---	312AHSF
25 ft. (7.6m)	---	325AHSF

CKCI50 GAS COOLED

1 PIECE STANDARD POWER CABLE



1 PIECE SUPER-FLEX POWER CABLE



2 PIECE STANDARD POWER CABLE



2 PIECE SUPER-FLEX POWER CABLE



LENGTH	STANDARD	SUPER-FLEX
	1 PIECE CABLE	1 PIECE CABLE
12-1/2 ft. (3.8m)	1512PCCM	1512PCCMSF
25 ft. (7.6m)	1525PCCM	1525PCCMSF
LENGTH	2 PIECE CABLES	2 PIECE CABLES
12-1/2 ft. (3.8m)	1512PCNM	1512PCNSFM
25 ft. (7.6m)	1525PCNM	1525PCNSFM
LENGTH	WELD LEAD	
12-1/2 ft. (3.8m)	1512CNM	
25 ft. (7.6m)	1525CNM	
LENGTH	ARGON HOSE	ARGON HOSE
12-1/2 ft. (3.8m)	212AH	212AHSF
25 ft. (7.6m)	225AH	225AHSF

FLI30, FLI50 GAS COOLED

1 PIECE STANDARD POWER CABLE



1 PIECE SUPER-FLEX POWER CABLE



LENGTH	STANDARD	SUPER-FLEX
	1 PIECE CABLE	1 PIECE CABLE
12-1/2 ft. (3.8m)	1512PCHF	1512PCSF
25 ft. (7.6m)	1525PCHF	1525PCSF

CK20, CK24W, CK25, CK180, CK200, CKM200, FL230, FL250, MRI40 WATER COOLED

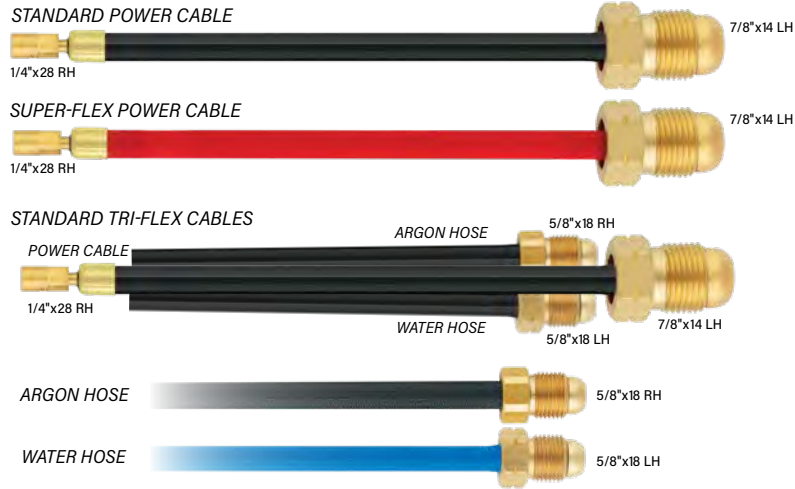

LENGTH	STANDARD	SUPER-FLEX
	POWER CABLE	POWER CABLE
12-1/2 ft. (3.8m)	212PC (45V03)	212PCSF (45V03SF)
25 ft. (7.6m)	225PC (45V04)	225PCSF (45V04SF)

LENGTH	TRI-FLEX CABLES	3-PIECE ASSEMBLY
	12-1/2 ft. (3.8m)	212TF
25 ft. (7.6m)	225TF	225SF

LENGTH	WATER HOSE	WATER HOSE
	12-1/2 ft. (3.8m)	212WH (45V07)
25 ft. (7.6m)	225WH (45V08)	225WHSF (45V08SF)

LENGTH	ARGON HOSE	ARGON HOSE
	12-1/2 ft. (3.8m)	212AH (45V09)
25 ft. (7.6m)	225AH (45V10)	225AHSF (45V10SF)

CK18, CK300 WATER COOLED

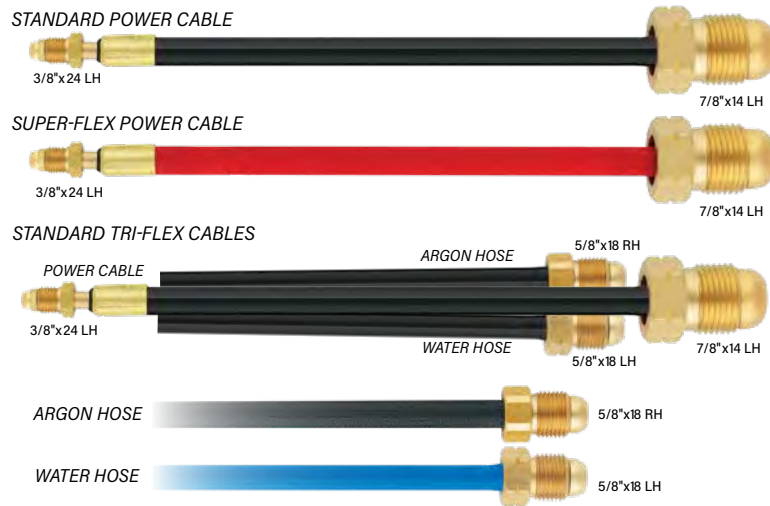

LENGTH	STANDARD	SUPER-FLEX
	POWER CABLE	POWER CABLE
12-1/2 ft. (3.8m)	312PC (40V64)	312PCSF (40V64SF)
25 ft. (7.6m)	325PC (41V29)	325PCSF (41V29SF)

LENGTH	TRI-FLEX CABLES	3-PIECE ASSEMBLY
	12-1/2 ft. (3.8m)	312TF
25 ft. (7.6m)	325TF	325SF

LENGTH	WATER HOSE	WATER HOSE
	12-1/2 ft. (3.8m)	312WH (40V74)
25 ft. (7.6m)	325WH (41V32)	325WHSF (41V32SF)

LENGTH	ARGON HOSE	ARGON HOSE
	12-1/2 ft. (3.8m)	312AH (40V75)
25 ft. (7.6m)	325AH (41V30)	325AHSF (41V30SF)

CK230, TL18, TL300 WATER COOLED

STANDARD POWER CABLE

3/8"x24 LH



7/8"x14 LH

SUPER-FLEX POWER CABLE

3/8"x24 LH



7/8"x14 LH

STANDARD TRI-FLEX CABLES

POWER CABLE

3/8"x24 LH



ARGON HOSE

5/8"x18 RH

WATER HOSE

5/8"x18 LH

7/8"x14 LH

ARGON HOSE

5/8"x18 RH

WATER HOSE

5/8"x18 LH

LENGTH	STANDARD	SUPER-FLEX
	POWER CABLE	POWER CABLE
12-1/2 ft. (3.8m)	2312PC	2312PCSF
25 ft. (7.6m)	2325PC	2325PCSF

LENGTH	TRI-FLEX CABLES	3-PIECE ASSEMBLY
	12-1/2 ft. (3.8m)	2312TF
25 ft. (7.6m)	2325TF	2325SF

LENGTH	WATER HOSE	WATER HOSE
12-1/2 ft. (3.8m)	212WH (45V07)	212WHSF (45V07SF)
25 ft. (7.6m)	225WH (45V08)	225WHSF (45V08SF)

LENGTH	ARGON HOSE	ARGON HOSE
12-1/2 ft. (3.8m)	212AH (45V09)	212AHSF (45V09SF)
25 ft. (7.6m)	225AH (45V10)	225AHSF (45V10SF)

CK350, CK510, CK18HD WATER COOLED

STANDARD POWER CABLE

3/8"x24 LH



7/8"x14 LH

SUPER-FLEX POWER CABLE

3/8"x24 LH



7/8"x14 LH

ARGON HOSE

5/8"x18 RH

WATER HOSE

5/8"x18 LH

LENGTH	STANDARD	SUPER-FLEX
	POWER CABLE	POWER CABLE
12-1/2 ft. (3.8m)	512PC	512PCSF
25 ft. (7.6m)	525PC	525PCSF

LENGTH	WATER HOSE	WATER HOSE
12-1/2 ft. (3.8m)	312WH	312WHSF
25 ft. (7.6m)	325WH	325WHSF

LENGTH	ARGON HOSE	ARGON HOSE
12-1/2 ft. (3.8m)	312AH	312AHSF
25 ft. (7.6m)	325AH	325AHSF

AIRCO TORCH POWER CABLES/HOSES

CKA10 GAS COOLED

1 PIECE STANDARD POWER CABLE



1 PIECE SUPER-FLEX POWER CABLE



LENGTH	STANDARD	SUPER-FLEX
	1 PIECE CABLE	1 PIECE CABLE
12-1/2 ft. (3.8m)	A2PC10	A2PC10SF
25 ft. (7.6m)	A5PC10	A5PC10SF

CKA16 GAS COOLED

1 PIECE STANDARD POWER CABLE



1 PIECE SUPER-FLEX POWER CABLE



LENGTH	STANDARD	SUPER-FLEX
	1 PIECE CABLE	1 PIECE CABLE
12-1/2 ft. (3.8m)	412PCHF	412PCSF
25 ft. (7.6m)	425PCHF	425PCSF

2 PIECE STANDARD POWER CABLE



2 PIECE SUPER-FLEX POWER CABLE

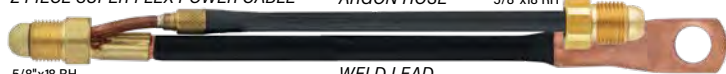

LENGTH	2 PIECE CABLES	2 PIECE CABLES
	12-1/2 ft. (3.8m)	412PCN
25 ft. (7.6m)	425PCN	425PCNSF

LENGTH	WELD LEAD
12-1/2 ft. (3.8m)	412CN
25 ft. (7.6m)	425CN

LENGTH	ARGON HOSE	ARGON HOSE
12-1/2 ft. (3.8m)	312AH	312AHSF
25 ft. (7.6m)	325AH	325AHSF

CKA20 WATER COOLED

STANDARD TRI-FLEX CABLES



STANDARD POWER CABLE



SUPER-FLEX POWER CABLE



LENGTH	STANDARD	SUPER-FLEX
	TRI-FLEX CABLES	
12-1/2 ft. (3.8m)	A2TF20	
25 ft. (7.6m)	A5TF20	

LENGTH	POWER CABLE	POWER CABLE
12-1/2 ft. (3.8m)	A2PC20	A2PC20SF
25 ft. (7.6m)	A5PC20	A5PC20SF

LENGTH	WATER HOSE	WATER HOSE
12-1/2 ft. (3.8m)	212WH	212WHSF
25 ft. (7.6m)	225WH	225WHSF

LENGTH	ARGON HOSE	ARGON HOSE
12-1/2 ft. (3.8m)	212AH	212AHSF
25 ft. (7.6m)	225AH	225AHSF

CKA35 WATER COOLED

STANDARD TRI-FLEX CABLES



STANDARD POWER CABLE



SUPER-FLEX POWER CABLE



LENGTH	STANDARD	SUPER-FLEX
	TRI-FLEX CABLES	
12-1/2 ft. (3.8m)	A2TF35	
25 ft. (7.6m)	A5TF35	

LENGTH	POWER CABLE	POWER CABLE
12-1/2 ft. (3.8m)	A2PC35	A2PC35SF
25 ft. (7.6m)	A5PC35	A5PC35SF

LENGTH	WATER HOSE	WATER HOSE
12-1/2 ft. (3.8m)	312WH	312WHSF
25 ft. (7.6m)	325WH	325WHSF

LENGTH	ARGON HOSE	ARGON HOSE
12-1/2 ft. (3.8m)	312AH	312AHSF
25 ft. (7.6m)	325AH	325AHSF

MACHINE POWER CABLES/HOSES

MT100 GAS COOLED

1 PIECE STANDARD POWER CABLE



3/8"x24 Female

1 PIECE SUPER-FLEX POWER



3/8"x24 Female

LENGTH	STANDARD	SUPER-FLEX
	1-PIECE CABLE	1-PIECE CABLE
12-1/2 ft. (3.8m)	M112PC	M112PCSF
25 ft. (7.6m)	M125PC	M125PCSF

MT400 WATER COOLED

1 PIECE STANDARD POWER CABLE



3/8"x24 Female

1 PIECE SUPER-FLEX POWER CABLE



3/8"x24 Female

ARGON HOSE



WATER HOSE



LENGTH	STANDARD	SUPER-FLEX
	1-PIECE CABLE	1-PIECE CABLE
12-1/2 ft. (3.8m)	M512PC-1	M512PCSF-1
25 ft. (7.6m)	M525PC-1	M525PCSF-1

LENGTH	WATER HOSE	WATER HOSE
12-1/2 ft. (3.8m)	212WH	212WHSF
25 ft. (7.6m)	225WH	225WHSF

LENGTH	ARGON HOSE	ARGON HOSE
12-1/2 ft. (3.8m)	212AH	212AHSF
25 ft. (7.6m)	225AH	225AHSF

MT500 WATER COOLED

1 PIECE STANDARD POWER CABLE



3/8"x24 Female

1 PIECE SUPER-FLEX POWER CABLE



3/8"x24 Female

ARGON HOSE



WATER HOSE



LENGTH	STANDARD	SUPER-FLEX
	1-PIECE CABLE	1-PIECE CABLE
12-1/2 ft. (3.8m)	M512PC-1	M512PCSF-1
25 ft. (7.6m)	M525PC-1	M525PCSF-1

LENGTH	WATER HOSE	WATER HOSE
12-1/2 ft. (3.8m)	312WH	312WHSF
25 ft. (7.6m)	325WH	325WHSF

LENGTH	ARGON HOSE	ARGON HOSE
12-1/2 ft. (3.8m)	312AH	312AHSF
25 ft. (7.6m)	325AH	325AHSF

CKM230 WATER COOLED

STANDARD TRI-FLEX CABLES



SUPER-FLEX POWER CABLE



3/8"x24 LH

ARGON HOSE



WATER HOSE



LENGTH	STANDARD	SUPER-FLEX
	TRI-FLEX CABLES	3-PIECE ASSEMBLY
12-1/2 ft. (3.8m)	2312TF	2312SF
25 ft. (7.6m)	2325TF	2325SF

LENGTH	POWER CABLE	POWER CABLE
12-1/2 ft. (3.8m)	2312PC	2312PCSF
25 ft. (7.6m)	2325PC	2325PCSF

LENGTH	WATER HOSE	WATER HOSE
12-1/2 ft. (3.8m)	212WH	212WHSF
25 ft. (7.6m)	225WH	225WHSF

LENGTH	ARGON HOSE	ARGON HOSE
12-1/2 ft. (3.8m)	212AH	212AHSF
25 ft. (7.6m)	225AH	225AHSF

CKM350 WATER COOLED

STANDARD POWER CABLE



3/8"x24 LH

SUPER-FLEX POWER CABLE



3/8"x24 LH

ARGON HOSE



WATER HOSE



LENGTH	STANDARD	SUPER-FLEX
	POWER CABLE	POWER CABLE
12-1/2 ft. (3.8m)	512PC	512PCSF
25 ft. (7.6m)	525PC	525PCSF

LENGTH	WATER HOSE	WATER HOSE
12-1/2 ft. (3.8m)	312WH	312WHSF
25 ft. (7.6m)	325WH	325WHSF

LENGTH	ARGON HOSE	ARGON HOSE
12-1/2 ft. (3.8m)	312AH	312AHSF
25 ft. (7.6m)	325AH	325AHSF

GAS HOSE CK EXCLUSIVE

Reinforced clear vinyl 1/4" (6.4mm) inside diameter hose can be ordered in multiple lengths from 12-1/2' (3.8m) to 100' (30.5m) with fittings and as a bulk 300' (91.4m) bulk reel without fittings.

REINFORCED GAS HOSE | 1/4" (6.4mm)

FITTINGS	LENGTH*	INSIDE DIAMETER	ORDER#
5/8"-18RH MALE BOTH ENDS	12-1/2 ft. (3.8m)	1/4" (6.4mm)	ARH-12
	25 ft. (7.6m)	1/4" (6.4mm)	ARH-25
	50 ft. (15.2m)	1/4" (6.4mm)	ARH-50
	75 ft. (22.9m)	1/4" (6.4mm)	ARH-75
BULK NO FITTINGS	100 ft. (30.5m)	1/4" (6.4mm)	ARH-100
	300 ft. (91.4m)	1/4" (6.4mm)	ARH-BULK*

*300' (91.4m) reels only, NO EXCEPTIONS



REGULATORS

Our Regulator/Flowmeter combinations are specially designed for TIG welding applications. Unique design and construction features make these units equally suited for applications from the industrial job site to the laboratory.

191AR-60 | SINGLE

- Regulator/flowmeter combination in one compact unit
- Ideal for applications where dependability is needed
- Regulator is preset at 50PSIG
- Machined brass body and housing cap
- Cover tube contains overpressure protection



196AR-60 | DOUBLE

- Monitors two separate gas flow settings at the same time
- Dual flowmeter allows for purging operations
- Regulator is preset at 50PSIG
- Single-stage construction
- Body machined from class "A" brass



GAS FLOW TESTER

CK-GFT | TESTER

Use the CK-GFT to quickly and easily check your flow rate AT THE TORCH NOZZLE!

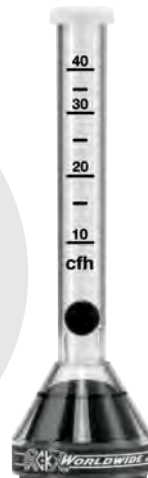

WEDGE COLLET CK EXCLUSIVE

LASTS UP TO 10 TIMES LONGER THAN STANDARD SPLIT COLLETS

- Improves arc starts and arc stability
- Requires less pressure from the backcap, improving thread life on torch head
- Tungsten is in direct contact with collet body creating less resistance heating
- Runs cooler, minimizing down time replacing collets
- Eliminates twisting and deformation of collet
- Fits any standard collet body or gas lens

Precision angled end cut gives "wedge" action for firm hold

Slots weaken the collet allowing it to twist, deform or jam



WEDGE COLLETS

USE ON TORCHES	TUNGSTEN SIZE	ORDER#
CK9, CK20 (2 Series)	.040" (1.0mm)	2C040GS
	1/16" (1.6mm)	2C116GS
	3/32" (2.4mm)	2C332GS
	1/8" (3.2mm)	2C418GS

USE ON TORCHES	TUNGSTEN SIZE	ORDER#
CK17, CK18, CK26 (3 Series)	.040" (1.0mm)	3C040GS
	1/16" (1.6mm)	3C116GS
	3/32" (2.4mm)	3C332GS
	1/8" (3.2mm)	3C418GS
	5/32" (4.0mm)	3C532GS

MAGNETIC TORCH HOLDER

MTH-15 | HOLDER

Keep your torch and consumables safe from drops or falls!

- Attaches vertically or horizontally to fit your needs
- Magnetic base for easy attachment and strong hold
- Protects your torch and consumables

Magnetic base attaches vertically or horizontally to work surfaces



E-Z DABR™

EZ DABR | TUNGSTEN HOLDER

The E-Z DABR is your perfect companion in mastering one of TIG welding's most intricate skills—feeding filler wire. Whether you're a beginner eager to learn quickly or a disabled welder seeking a stable hand to feed your puddle, the E-Z DABR has your back. This tool is equipped with a flexible guide tube that attaches to your gloved finger, offering a hands-on experience to develop the dexterity and control needed for precise filler metal delivery. The kit includes the filler feeder along with tips suitable for 1/16" and 3/32" filler wire sizes.

Flexible spring head

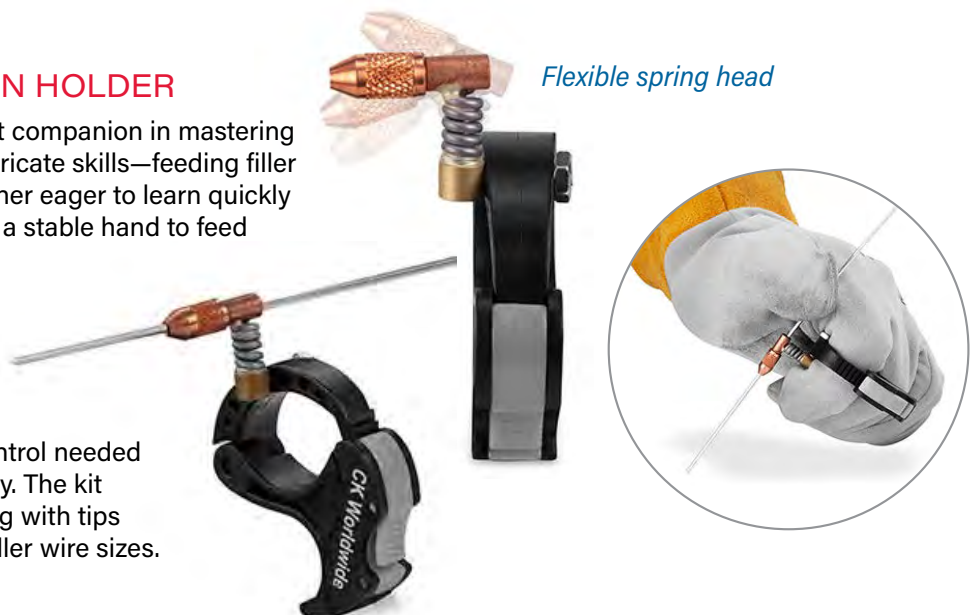

PREMIUM PURGE CUPS & TRAILING SHIELDS

When welding with metals such as Titanium, a secondary inert shielding gas application is necessary to protect the cooling weld bead and heat-affected zone. Trailing cups prevent oxidation by shielding the weld from the atmosphere until it has cooled to a safe temperature. 12-1/2 foot (3.8m) argon hose included with each item.



PURGE CUP
4" (10.2cm) ORDER # PC-4S



TRAILING SHIELD
3" (7.6cm) ORDER # TC-3S



TRAILING SHIELD
3"- 5" (7.6 -12.7cm)
Diameter Pipe
ORDER # TC-3R



STANDARD TRAILING SHIELDS

- Clips onto standard or jumbo gas lens cups
- Uses a modified jumbo gas lens as trailing shield
- Can be repositioned for different weld angles
- Includes 25 foot (7.62m) Argon hose

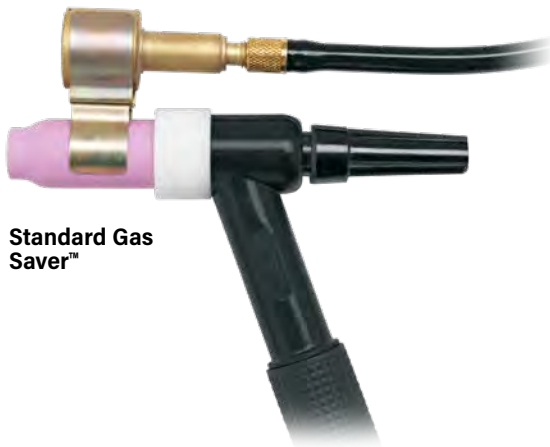

Standard Gas Saver™



Large Diameter Gas Saver™

TRAILING SHIELDS |

USE ON TORCHES	CUP SIZE	ORDER#
CK9, CK20	Standard	TS200
CK17, CK18, CK26	Standard	TS300
CK9, CK17, CK18, CK20, CK26	Large Diameter	TS300LD

TUNGSTEN ELECTRODE GRINDER

The Turbo-Sharp® X enclosed electrode grinder minimizes dust exposure to both the user and the environment while delivering consistent tip geometry.

- Standard head for diameters:
 .040" (1.0mm) 1/16" (1.6mm)
 3/32" (2.4mm) 1/8" (3.2mm)
- Angles adjustable from 20°- 60°
- Eliminate grinding wheel contamination

TURBO-SHARP® X

SPECIAL FEATURES:

- Multi-functional cover**
Through a slot in the cover one can flatten the electrode to prepare a truncated cone.
- Setting the angle**
Angles adjustable from 20°- 60°
- Grinding disc**
Both sides coated with diamond-powder, giving double wheel life.
- Unbelievable result**
TURBO-SHARP® X allows exact repetition of longitudinal grinding.
- Ergonomic**
TURBO-SHARP® X is optimal with respect to weight and handling.



Both sides coated with diamond-powder

SPECIFICATIONS

VOLTAGE	120V AC
SINGLE PHASE	60 Hz
POWER	710 W
AMPS	6.45
NO LOAD SPEED	34,000 RPM
WEIGHT	4.1 pounds
	1,860 grams
SHIP WEIGHT	10.1 pounds
	4,581 grams
WARRANTY	2 years

230V available, contact us for more information



TURBO-SHARP® X can be equipped with an optional grinder head (TS3-HR).

Using the red head, you can grind electrodes of diameter: 1/8" (3.2mm), 5/32" (4.0mm), 3/16" (4.8mm) and 1/4" (6.4mm)



Turbo-Sharp® X is a registered trademark of JAS.

CONSISTENT RESULTS:
Stepless grinding angles 20°- 60°

SHORT TUNGSTEN KIT FOR USE WITH TS3-HR GRINDER HEAD ONLY

HOLDS SHORTER LENGTH TUNGSTEN

Grind tungstens as short as 3/4" (1.9cm)

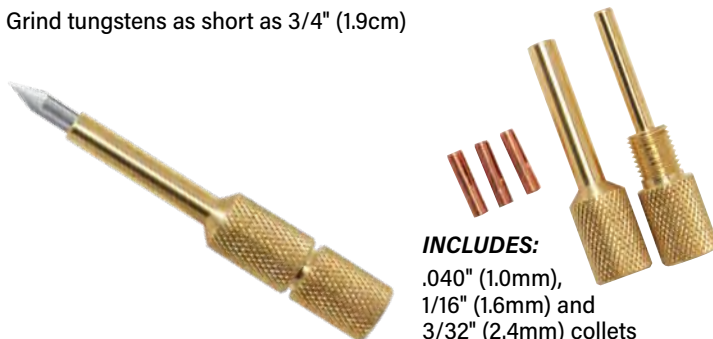

INCLUDES:
.040" (1.0mm),
1/16" (1.6mm) and
3/32" (2.4mm) collets

TURBO-SHARP X | ORDERING INFO

DESCRIPTION	ORDER #
120 V GRINDER (Includes TS3-HB)	TS10
230 V GRINDER (Includes TS3-HB)	TS10-230
REPLACEMENT WHEEL	TS3-W
GRINDER HEAD .040"-1/8" (1.0mm - 3.2mm)	TS3-HB
GRINDER HEAD 1/8" (3.2mm), 5/32" (4.0mm), 3/16" (4.8mm), 1/4" (6.4mm)	TS3-HR
SHORT TUNGSTEN KIT (TS3-HR required)	TS3-STK

TUNGSTEN ELECTRODES

2% THORIATED (RED) EWTh-2/WT20

Principal Oxide: 1.7-2.2% Thorium Oxide

Radioactive. Best for use in Direct Current (D/C) applications using transformer based constant current power sources. Best for use on non corroding steels, titanium alloys, nickel alloys, copper alloys. Good D/C arc starts and stability, medium erosion rate, medium amperage range, medium tendency to spit.

0.8% ZIRCONIATED (WHITE) EWZr-8/WZ8

Principal Oxide: 0.7-0.9% Zirconium Oxide

Non-Radioactive. Best for use in Alternating Current (A/C) for aluminum alloys and magnesium alloys using inverter or transformer based constant current power sources. Balls well, handles higher amperage than pure tungsten with less pitting, better arc starts and arc stability than pure tungsten.

1.5% LANTHANATED (GOLD) EWLa-1.5/WL15

Principal Oxide: 1.3-1.7% Lanthanum Oxide

Non-Radioactive. Best for use in Direct Current (D/C) as an alternative to 2% Thoriated using inverter or transformer based constant current power sources. Best for non corroding steels, titanium alloys, nickel alloys, copper alloys. Best D/C arc starts and stability, low erosion rate, wide amperage range, no spitting.

2% CERIATED (GRAY) FORMERLY ORANGE EWCe-2/WC20

Principal Oxide: 1.8-2.2% Cerium Oxide

Non-Radioactive. Best for use in Alternating Current (A/C) or Direct Current (D/C) applications using inverter or transformer based constant current power sources. Good for low-alloyed steels, non corroding steels, aluminum alloys, magnesium alloys, titanium alloys, nickel alloys, copper alloys. Good ignition and re-ignition properties, long service life, excellent arc stability. Low erosion rate, best at low amperage range, no spitting, good D/C arc starts and stability.

PURE (GREEN) EWP/WP

Principal Oxide: None

NON-RADIOACTIVE. Good for use in Alternating Current (A/C) for aluminum alloys and magnesium alloys in low to medium amperage applications using transformer based constant current power sources only. Balls easy, tends to spit at higher amperages. Used for non-critical welds only.

2% LANTHANATED (BLUE) EWLa-2/WL20

Principal Oxide: 1.8-2.2% Lanthanum Oxide







Non-Radioactive. Best general purpose electrode for both Alternating Current (A/C) or Direct Current (D/C) using inverter or transformer based constant current power sources. Good for low-alloyed steels, non corroding steels, aluminum alloys, magnesium alloys, titanium alloys, nickel alloys, copper alloys. Good arc starts and stability, medium to high amperage range, low erosion rate.

LaYzr™ (CHARTREUSE) EWG

Principal Oxides: 1.5% Lanthanum, 0.8% Yttrium Oxides, 0.8% Zirconium

Non-Radioactive. Best for automated or robotic applications in Alternating Current (A/C) or Direct Current (D/C) due to low voltage tolerance (changes in tip to work piece distance) using inverter or transformer based constant current power sources. Good for low-alloyed steels, non corroding steels, aluminum alloys, magnesium alloys, titanium alloys, nickel alloys, copper alloys. Very stable tip geometry, runs cooler than 2% Thoriated with longer life, low to medium amperage range. Very best low amperage starts.

Color Code and Alloying Elements for Various Tungsten Electrode Alloys

Designation		Chemical Composition Impurities ≤0.1%		TIP COLOR
ISO 6848	AWS A5.12	OXIDE ADDITIVE	TUNGSTEN	
WT20	EWTh-2	ThO ₂ : 1.70-2.20%	≥97.30%	Red 
WP	EWP	~~~~~	≥99.95%	Green 
WL15	EWLa-1.5	LaO ₂ : 1.30-1.70%	≥97.80%	Gold 
WC20	EWCe-2	CeO ₂ : 1.80-2.20%	≥97.30%	Gray 
WL20	EWLa-2	La ₂ O ₃ : 1.80-2.20%	≥97.30%	Blue 
WZ8	EWZr-8	ZrO ₂ : 0.70-0.90%	≥98.60%	White 
LaYzr	EWG	La ₂ O ₃ : 1.3-1.7%; ZrO ₂ : 0.06-0.10%; Y ₂ O ₃ : 0.6-1.0%	≥98.34%	Chartreuse 

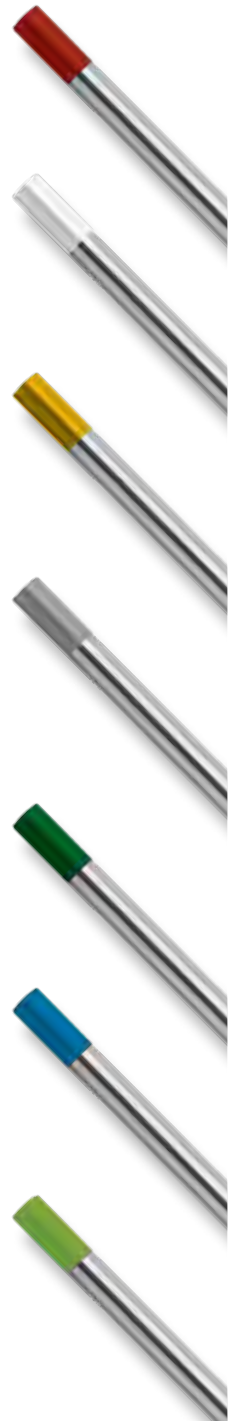

TUNGSTEN RETAIL PACKS

Oxides used are primarily zirconium, thorium, lanthanum or cerium. Additions are usually 1% – 4%. These oxides greatly improve arc initiation, especially when direct current (DC) welding is employed. Thorium oxide (thoria) has been used for many years, having been found effective in terms of long life and thermal efficiency. Zirconium oxide (zirconia) has been commonly used for alternating (AC) TIG welding, normally for welding aluminum.

ISO 6848 COLOR CHART	SIZE		PART #	
	INCHES	MILLIMETERS	10 PIECE	3 PIECE P.O.P.
2% Thoriated Red AWS A5.12 EWTh-2 ISO 6848 WT20	.020 x 7"	0.5 x 175mm	T0207GT2	
	.040 x 7"	1.0 x 175mm	T0407GT2	
	1/16 x 7"	1.6 x 175mm	T1167GT2	T1167GT2-3
	3/32 x 7"	2.4 x 175mm	T3327GT2	T3327GT2-3
	1/8 x 7"	3.2 x 175mm	T187GT2	T187GT2-3
.8% Zirconiated White AWS A5.12 EWZr-8 ISO 6848 WZ8	.020 x 7"	0.5 x 175mm	T0207GZ	
	.040 x 7"	1.0 x 175mm	T0407GZ	
	1/16 x 7"	1.6 x 175mm	T1167GZ	T1167GZ-3
	3/32 x 7"	2.4 x 175mm	T3327GZ	T3327GZ-3
	1/8 x 7"	3.2 x 175mm	T187GZ	T187GZ-3
1.5% Lanthanated Gold AWS A5.12 EWL-1.5 ISO 6848 WL15	.020 x 7"	0.5 x 175mm	T0207GL	
	.040 x 7"	1.0 x 175mm	T0407GL	
	1/16 x 7"	1.6 x 175mm	T1167GL	T1167GL-3
	3/32 x 7"	2.4 x 175mm	T3327GL	T3327GL-3
	1/8 x 7"	3.2 x 175mm	T187GL	T187GL-3
2% Ceriated Gray AWS A5.12 EWCe-2 ISO 6848 WC20 (Formerly Orange)	.020 x 7"	0.5 x 175mm	T0207GC2	
	.040 x 7"	1.0 x 175mm	T0407GC2	
	1/16 x 7"	1.6 x 175mm	T1167GC2	T1167GC2-3
	3/32 x 7"	2.4 x 175mm	T3327GC2	T3327GC2-3
	1/8 x 7"	3.2 x 175mm	T187GC2	T187GC2-3
Pure Green AWS A5.12 EWP ISO 6848 WP	.020 x 7"	0.5 x 175mm	T0207G	
	.040 x 7"	1.0 x 175mm	T0407G	
	1/16 x 7"	1.6 x 175mm	T1167G	T1167G-3
	3/32 x 7"	2.4 x 175mm	T3327G	T3327G-3
	1/8 x 7"	3.2 x 175mm	T187G	T187G-3
2% Lanthanated Blue AWS A5.12 EWL-2 ISO 6848 WL20	.020 x 7"	0.5 x 175mm	T0207GL2	
	.040 x 7"	1.0 x 175mm	T0407GL2	
	1/16 x 7"	1.6 x 175mm	T1167GL2	T1167GL2-3
	3/32 x 7"	2.4 x 175mm	T3327GL2	T3327GL2-3
	1/8 x 7"	3.2 x 175mm	T187GL2	T187GL2-3
LaYzr™ Chartreuse AWS A5.12 EWG ISO 6848	.020 x 7"	0.5 x 175mm	T0207GTM	
	.040 x 7"	1.0 x 175mm	T0407GTM	
	1/16 x 7"	1.6 x 175mm	T1167GTM	T1167GTM-3
	3/32 x 7"	2.4 x 175mm	T3327GTM	T3327GTM-3
	1/8 x 7"	3.2 x 175mm	T187GTM	T187GTM-3
	5/32 x 7"	4.0 x 175mm	T5327GTM	



TIG welding electrodes usually contain small quantities of metallic oxides, which can offer the following benefits:

- Facilitate arc starting
- Increase arc stability
- Improve current carrying capacity of the electrode
- Reduce the risk of weld contamination
- Increase electrode life

LARGER DIAMETER 3/16" - 1/4" TUNGSTEN 5-PACKS AVAILABLE
Call for details.

TUNGSTEN STICK OUT GAUGE

- Loosen knurled lock nut
- Turn threaded gauge rod to adjust gauge depth (markings are in 1/16th inch increments)
- Lock gauge by turning knurled lock nut firmly against the gauge body

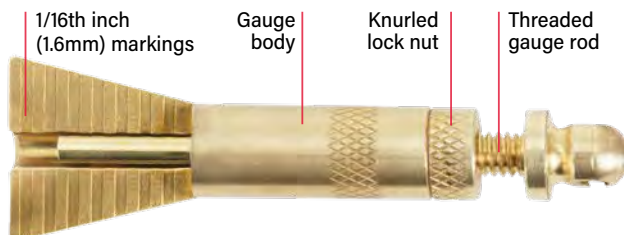

STICK-OUT GAUGE

DESCRIPTION	ORDER #	DETAILS
Standard Gauge	TG1	Includes convenient key ring
Small Tungsten Gauge	TG1-24	

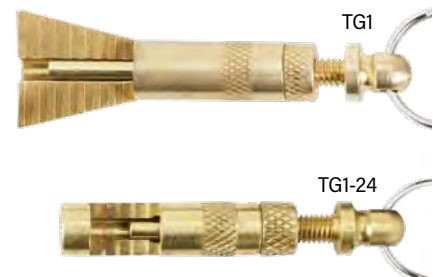

SUPER CUPS

THE RIGHT NOZZLE FOR THE TOUGHEST TIG WELDING APPLICATIONS

Super Cups withstand high-amperage and high-reflective heat applications while minimizing cracking problems related to thermal shock.

- Lasts longer in high-heat applications than alumina cups
- Reduce downtime
- Reduce replacement part costs
- Reduce thermal conductivity by approximately 40%



Super Cups minimize cracking problems related to thermal shock. Save time and money while reducing thermal conductivity by 40%.

Available to fit all 2 and 3 Series torches.

SERIES 2 SUPER CUPS TORCH MODELS 9, 20



STANDARD		GAS LENS		LARGE DIAMETER	
2S4	(13N08SC)	2SG4	(53N58SC)	3SG6LD	(57N75SC)
2S5	(13N09SC)	2SG5	(53N59SC)	3SG8LD	(57N74SC)
2S6	(13N10SC)	2SG6	(53N60SC)	3SG10LD	(53N88SC)
2S7	(13N11SC)	2SG7	(53N61SC)	3SG12LD	(53N87SC)
2S8	(13N12SC)	2SG8	(53N61SSC)		
2S10	(13N13SC)				

SERIES 3 SUPER CUPS TORCH MODELS 17, 18, 26



STANDARD		GAS LENS		LARGE DIAMETER	
3S4	(10N50SC)	3SG4	(54N18SC)	3SG6LD	(57N75SC)
3S5	(10N49SC)	3SG5	(54N17SC)	3SG8LD	(57N74SC)
3S6	(10N48SC)	3SG6	(54N16SC)	3SG10LD	(53N88SC)
3S7	(10N47SC)	3SG7	(54N15SC)	3SG12LD	(53N87SC)
3S8	(10N46SC)	3SG8	(54N14SC)		
3S10	(10N45SC)				
3S12	(10N44SC)				

UNDERSTANDING CK WORLDWIDE PART NUMBERS

Please note this is a general formula that works for most CK part numbers and that there may be products that do not follow these guidelines. If you have any questions, please call our customer service line at 1 (800) 426-0877.

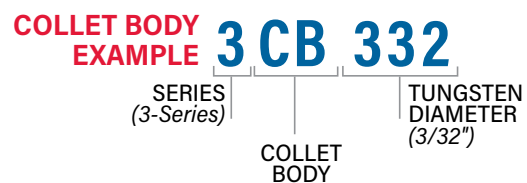
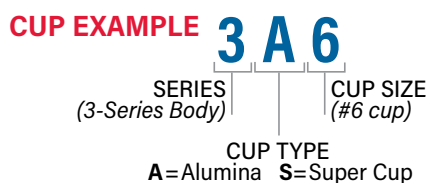

2 SERIES (13N) TORCH MODELS 9, 20

THREAD PATTERN: 5/16" x 24

CUP	COLLET BODY	COLLET	HEATSHIELD	TORCH	BACKCAP
STANDARD 2S4 (13N08SC) 2S5 (13N09SC) 2S6 (13N10SC) 2S7 (13N11SC) 2S8 (13N12SC) 2S10 (13N13SC)	STANDARD 2CB20 (13N25) 2CB40 (13N26) 2CB116 (13N27) 2CB332 (13N28) 2CB418 (13N29)	STANDARD 2C20 (13N20) 2C40 (13N21) 2C116 (13N22) 2C332 (13N23) 2C418 (13N24) WEDGE 2C040GS 2C332GS 2C116GS 2C418GS REVERSE 6C20 6C332 6C40 6C418 6C116	STANDARD 2GHS	<p>LONG 200L (41V24)</p> <p>MEDIUM 200M (41V35)</p> <p>SHORT 200S (41V33)</p> <p>TORCHES USED ON: CK9 CK20 CK25 CK100 CK110 CK130 CK200 CK230 FL2L (FL130/ FL230) CKM230 CWH230 CWM230</p>	STANDARD 2GHS
GAS LENS 2SG4 (53N58SC) 2SG5 (53N59SC) 2SG6 (53N60SC) 2SG7 (53N61SC) 2SG8 (53N61SSC)	STANDARD 2GL20 (45V41) 2GL40 (45V42) 2GL116 (45V43) 2GL332 (45V44) 2GL418 (45V45)	STANDARD SEE ABOVE WEDGE SEE ABOVE REVERSE SEE ABOVE	STANDARD SEE ABOVE		
LARGE DIAMETER 3SG6LD (57N75SC) 3SG8LD (57N74SC) 3SG10LD (53N88SC) 3SG12LD (53N87SC)	LARGE DIAMETER 2GL0204LD (45V0204S) 2GL116LD (45V116S) 2GL332LD (45V64S) 2GL418LD (995795S)	LARGE DIAMETER 2C020LD (13N20L) 2C040LD (13N21L) 2C116LD (13N22L) 2C332LD (13N23L) 2C418LD (13N24L)	LARGE DIAMETER 2GHSLD		

3 SERIES (10N) TORCH MODELS 17, 18, 26

THREAD PATTERN: 3/8" x 32

CUP	COLLET BODY	COLLET	HEATSHIELD	TORCH	BACKCAP
STANDARD 3S4 (10N50SC) 3S5 (10N49SC) 3S6 (10N48SC) 3S7 (10N47SC) 3S8 (10N46SC) 3S10 (10N45SC) 3S12 (10N44SC)	STANDARD 3CB20 (10N29) 3CB40 (10N30) 3CB116 (10N31) 3CB332 (10N32) 3CB418 (10N28) 3CB532 (406488)	STANDARD 3C20 (10N21) 3C40 (10N22) 3C116 (10N23) 3C332 (10N24) 3C418 (10N25) 3C532 (54N20) WEDGE 3C040GS 3C418GS 3C116GS 3C532GS 3C332GS REVERSE 7C20 7C332 7C40 7C418 7C116 7C532	STANDARD 300HS	<p>LONG 300L (57Y02)</p> <p>MEDIUM 300M (34015)</p> <p>SHORT 300S (57Y04)</p> <p>TORCHES USED ON: CK17 CK18/CK18HD CK26 CK150 CKC150 CK210 CK300 CK510 TL18 TL26 TL210 TL300 FL3L (FL150/ FL250) CKM350 CWHTL300* CWH350* CWM350*</p> <p>*Heatshield not shown. (Contact factory for part number)</p>	STANDARD 300HS
GAS LENS 3SG4 (54N18SC) 3SG5 (54N17SC) 3SG6 (54N16SC) 3SG7 (54N15SC) 3SG8 (54N14SC)	GAS LENS 3GL20 (45V29) 3GL40 (45V24) 3GL116 (45V25) 3GL332 (45V26) 3GL418 (45V27) 3GL532 (45V28)	STANDARD SEE ABOVE WEDGE SEE ABOVE REVERSE SEE ABOVE	GAS LENS 3GHS		
LARGE DIAMETER 3SG6LD (57N75SC) 3SG8LD (57N74SC) 3SG10LD (53N88SC) 3SG12LD (53N87SC)	LARGE DIAMETER 3GL116LD (45V116) 3GL332LD (45V64) 3GL418LD (995795) 3GL532LD (45V63)	REVERSE SEE ABOVE	LARGE DIAMETER 3GHSLD		
ALUMINA - GAS LENS 2SG4 (53N58SC) 2SG5 (53N59SC)	SHORT - GAS LENS 4GL20 4GL332 4GL40 4GL418 4GL116 4GL532	SHORT SEE PAGE 68 SHORT WEDGE SEE PAGE 68	SHORT - GAS LENS 4GHS		

2 SERIES (13N) TORCH MODELS 9, 20

THREAD PATTERN: 5/16" x 24

CUP	COLLET BODY	COLLET	HEATSHIELD	TORCH	BACKCAP	
ALUMINA 2A4 (13N08) 2A7 (13N11) 2A5 (13N09) 2A8 (13N12) 2A6 (13N10) 2A10 (13N13)	STANDARD 2CB20 (13N25) 2CB40 (13N26) 2CB116 (13N27) 2CB332 (13N28) 2CB418 (13N29)	STANDARD 2C20 (13N20) 2C40 (13N21) 2C116 (13N22) 2C332 (13N23) 2C418 (13N24)	STANDARD 2GHS		LONG 200L (41V24)	
ALUMINA - LONG 2A3L (A796F70) 2A5L (A796F72) 2A4L (A796F71) 2A6L (A796F73)		WEDGE 2C040GS 2C332GS 2C116GS 2C418GS				MEDIUM 200M (41V35)
		REVERSE 6C20 6C332 6C40 6C418 6C116				SHORT 200S (41V33)
ALUMINA - GAS LENS 2AG4 (53N58) 2AG7 (53N61) 2AG5 (53N59) 2AG8 (53N61S) 2AG6 (53N60) 2AG10	GAS LENS 2GL20 (45V41) 2GL40 (45V42) 2GL116 (45V43) 2GL332 (45V44) 2GL418 (45V45)	STANDARD SEE ABOVE WEDGE SEE ABOVE REVERSE SEE ABOVE	STANDARD SEE ABOVE			TORCHES USED ON: CK100 CK110 CK130 CK200 CK230 FL2L (FL130/ FL230) CKM230 CWH230 CWM230 CK9 CK20 CK25
ALUMINA LONG - GAS LENS 2AG5L (53N59L) 2AG7L (53N61L) 2AG6L (53N60L)						
ALUMINA - LARGE DIAMETER 3AG6LD (57N75) 3AG11LD (53N89) 3AG8LD (57N74) 3AG12LD (53N87) 3AG10LD (53N88)	LARGE DIAMETER 2GL0204LD (45V0204S) 2GL116LD (45V116S) 2GL332LD (45V64S) 2GL418LD (995795S)	LARGE DIAMETER 2C020LD (13N20L) 2C040LD (13N21L) 2C116LD (13N22L) 2C332LD (13N23L) 2C418LD (13N24L)	LARGE DIAMETER 2GHSLD			
ALUMINA 8A4 (A53N24) 8A5 (A53N25) 8A6 (A53N27)	SHORT 6CB20 6CB40 6CB116 6CB332 6CB418	REVERSE SEE ABOVE	STANDARD SEE ABOVE			

SIZE SUFFIX	INCHES	MILLIMETERS
20	.020"	.5mm
40	.040"	1.0mm
116	1/16"	1.6mm
332	3/32"	2.4mm
418	1/8"	3.2mm
532	5/32"	4.0mm
316	3/16"	4.8mm
14	1/4"	6.4mm

2C332 Size Suffix

2 SERIES GAS SAVER TORCH MODELS 9, 20

THREAD PATTERN: 5/16" x 24

CUP	ADAPTER	COLLET BODY	COLLET	HEATSHIELD	TORCH	BACKCAP	
ALUMINA 2A4GS 2A7GS 2A5GS 2A8GS 2A6GS	WITH SCREEN TAS040GS TAS116GS TAS332GS TAS418GS WITHOUT SCREEN TA040GS TA418GS TA116GS TA332GS	STANDARD 2CBGS-1	WEDGE 2C040GS 2C116GS 2C332GS 2C418GS	STANDARD 2HSGS-1		LONG 200L (41V24)	
CLEAR 2P8GS							MEDIUM 200M (41V35)
ALUMINA 2A18GSLD	LARGE DIAMETER WITH SCREEN TAS040GSLD TAS116GSLD TAS332GSLD TAS418GSLD	LARGE DIAMETER 2CBGSLD	WEDGE SEE ABOVE	LARGE DIAMETER 2HSGSLD			SHORT 200S (41V33)
CLEAR 2P18GSLD					TORCHES USED ON: CK100 CK110 CK130 CK200 CK230 FL2L (FL130/ FL230) CKM230 CWH230 CWM230 CK9 CK20 CK25		

3 SERIES (10N) TORCH MODELS 17,18,26

THREAD PATTERN: 3/8" x 32

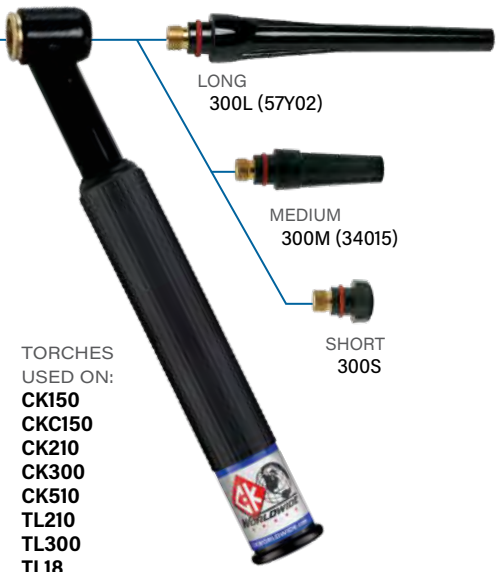
CUP	COLLET BODY	COLLET	HEATSHIELD	TORCH	BACKCAP
<p>ALUMINA</p> <p>3A4 (10N50) 3A5 (10N49) 3A6 (10N48) 3A7 (10N47)</p> <p>3A8 (10N46) 3A10 (10N45) 3A12 (10N44)</p> <p>ALUMINA - LONG</p> <p>3A5L (10N49L) 3A6L (10N48L) 3A7L (10N47L)</p>	<p>STANDARD</p> <p>3CB20 (10N29) 3CB40 (10N30) 3CB116 (10N31) 3CB332 (10N32) 3CB418 (10N28) 3CB532 (406488)</p>	<p>STANDARD</p> <p>3C20 (10N21) 3C40 (10N22) 3C116 (10N23) 3C332 (10N24) 3C418 (10N25) 3C532 (54N20)</p> <p>WEDGE</p> <p>3C040GS 3C418GS 3C116GS 3C532GS 3C332GS</p> <p>REVERSE</p> <p>7C20 7C332 7C40 7C418 7C116 7C532</p>	<p>STANDARD</p> <p>300HS</p>		<p>LONG</p> <p>300L (57Y02)</p> <p>MEDIUM</p> <p>300M (34015)</p> <p>SHORT</p> <p>300S</p>
<p>ALUMINA - GAS LENS</p> <p>3AG4 (54N18) 3AG7 (54N15) 3AG5 (54N17) 3AG8 (54N14) 3AG6 (54N16) 3AG11 (54N19) 3AG12</p> <p>ALUMINA LONG - GAS LENS</p> <p>OVERALL LENGTH 3" (7.6cm)</p> <p>3AG5L (54N17L) 3AG6L (54N16L) 3AG7L (54N15L) 3AG8L (54N14L)</p>	<p>GAS LENS</p> <p>3GL20 (45V29) 3GL40 (45V24) 3GL116 (45V25) 3GL332 (45V26) 3GL418 (45V27) 3GL532 (45V28)</p>	<p>STANDARD</p> <p>SEE ABOVE</p> <p>WEDGE</p> <p>SEE ABOVE</p> <p>REVERSE</p> <p>SEE ABOVE</p>	<p>GAS LENS</p> <p>3GHS</p>	<p>TORCHES USED ON:</p> <p>CK150 CKC150 CK210 CK300 CK510 TL210 TL300 TL18 TL26 FL3L (FL150/FL250) CK17 CK18/CK18HD CK26/CK26HD CKM350 CWH1300* CWH350* CWM350*</p> <p>*Contact CK Worldwide for heatshield.</p>	
<p>ALUMINA - LARGE DIAMETER</p> <p>3AG6LD (57N75) 3AG8LD (57N74) 3AG10LD (53N88) 3AG11LD (53N89) 3AG12LD (53N87)</p> <p>ALUMINA LONG - LARGE DIAMETER</p> <p>OVERALL LENGTH 2.75" (6.9cm)</p> <p>3AG6LDL (57N75L) 3AG8LDL (57N74L) 3AG10LDL (53N88L) 3AG12LDL (53N87L)</p> <p>ALUMINA EXTRA LONG - LARGE DIAMETER</p> <p>OVERALL LENGTH 3.25" (8.3cm)</p> <p>3AG6LDXL (57N75XL) 3AG8LDXL (57N74XL) 3AG10LDXL (53N88XL) 3AG12LDXL (53N87XL)</p>	<p>LARGE DIAMETER</p> <p>3GL116LD (45V116) 3GL332LD (45V64) 3GL418LD (995795) 3GL532LD (45V63)</p>	<p>STANDARD</p> <p>SEE ABOVE</p> <p>WEDGE</p> <p>SEE ABOVE</p> <p>REVERSE</p> <p>SEE ABOVE</p>	<p>LARGE DIAMETER</p> <p>3GHSLD</p>		

TUNGSTEN ELECTRODE CONVERSION CHART

SIZE SUFFIX	INCHES	MILLIMETERS
20	.020"	.5mm
40	.040"	1.0mm
116	1/16"	1.6mm
332	3/32"	2.4mm
418	1/8"	3.2mm
532	5/32"	4.0mm
316	3/16"	4.8mm
14	1/4"	6.4mm

3C332 Size Suffix

3 SERIES CONSUMABLES

ACCESSORIES & PARTS

3 SERIES GAS SAVER TORCH MODELS 17,18,26

THREAD PATTERN: 3/8"x 32

CUP	ADAPTER	COLLET BODY	COLLET	HEATSHIELD	TORCH	BACKCAP
<p>ALUMINA 3A4GS 3A5GS 3A6GS 3A7GS 3A8GS</p> <p>CLEAR 3P8GS</p>	<p>WITH SCREEN TAS040GS TAS116GS TAS332GS TAS418GS TAS532GS</p> <p>WITHOUT SCREEN TA040GS TA418GS TA116GS TA532GS TA332GS</p>	<p>STANDARD 3CBGS</p>	<p>WEDGE 3C040GS 3C116GS 3C332GS 3C418GS 3C532GS</p>	<p>STANDARD 3HSGS</p>	<p>TORCHES USED ON: CK150 CKC150 CK210 CK300 CK510 TL210 TL300 TL18 TL26 FL3L (FL150/FL250) CK17 CK18/CK18HD CK26/CK26HD MT100* MT400* MT500 CKM350 *Contact CK Worldwide for heatshield.</p>	<p>LONG 300L (57Y02)</p> <p>MEDIUM 300M (34015)</p> <p>SHORT 300S (57Y04)</p>
<p>ALUMINA 2A4GS 2A7GS 2A5GS 2A8GS 2A6GS</p> <p>CLEAR 2P8GS</p>	<p>WITH SCREEN SEE ABOVE</p> <p>WITHOUT SCREEN SEE ABOVE</p>	<p>SHORT 4CBGS</p>	<p>SHORT WEDGE 4C040GS 4C116GS 4C332GS 4C418GS 4C532GS</p>	<p>SHORT 3HSGS</p>		
<p>ALUMINA - GAS LENS 2A12GSLD</p> <p>ALUMINA 4A18GSLD</p> <p>CLEAR 4P18GSLD</p>	<p>LARGE DIAMETER WITH SCREEN TAS040GSLD TAS116GSLD TAS332GSLD TAS418GSLD TAS532GSLD</p>	<p>LARGE DIAMETER 4CBGSLD</p>	<p>SHORT WEDGE 4C040GS 4C116GS 4C332GS 4C418GS 4C532GS</p>	<p>LARGE DIAMETER 4HSGSLD</p>		

4 SERIES STUBBY TORCH MODELS 17,18,26

THREAD PATTERN: 3/8"x 32

CUP	COLLET BODY	COLLET	HEATSHIELD	TORCH	BACKCAP
<p>ALUMINA 2A4 (13N08) 2A5 (13N09) 2A6 (13N10)</p> <p>2A7 (13N11) 2A8 (13N12) 2A10 (13N13)</p>	<p>SHORT 4CB20 4CB332 4CB40 4CB418 4CB116 4CB532</p>	<p>SHORT 4C20 (10N21S) 4C40 (10N22S) 4C116 (10N23S) 4C332 (10N24S) 4C418 (10N25S) 4C532</p> <p>SHORT WEDGE 4C040GS 4C418GS 4C116GS 4C532GS 4C332GS</p> <p>REVERSE SEE PAGE 67</p>	<p>STANDARD 300HS</p>	<p>TORCHES USED ON: CK150 CKC150 CK210 CK300 CK510 TL210 TL300 TL18 TL26 FL3L (FL150/FL250) CK17 CK18/CK18HD CK26/CK26HD CKM350 CWHTL300* CWH350* CWM350* *Contact CK Worldwide for heatshield.</p>	<p>LONG 300L (57Y02)</p> <p>MEDIUM 300M (34015)</p> <p>SHORT 300S (57Y04)</p>
<p>ALUMINA - GAS LENS 2AG4 (53N58) 2AG8 (53N61S) 2AG5 (53N59) 2AG10 2AG6 (53N60) 2AG7 (53N61)</p>	<p>SHORT - GAS LENS 4GL20 4GL332 4GL40 4GL418 4GL116 4GL532</p>	<p>SHORT SEE ABOVE</p> <p>SHORT WEDGE SEE ABOVE</p> <p>REVERSE SEE PAGE 67</p>	<p>SHORT - GAS LENS 4GHS</p>		
<p>ALUMINA LONG - GAS LENS 2AG5L (53N59L) 2AG6L (53N60L) 2AG7L (53N61L)</p>					

5I SERIES TORCH MODEL CK510

THREAD PATTERN: 3/8"x 32 COLLET BODY: 5/8"x18

CUP	COLLET BODY	NOSE BLOCK	COLLET	HEATSHIELD	TORCH	BACKCAP
ALUMINA 3AG6LD (57N75) 3AG8LD (57N74) 3AG10LD (53N88) 3AG11LD (53N89) 3AG12LD (53N87)	STANDARD 51GL116 51GL332 51GL418 51GL532 51GL316 51GL1400	STANDARD ANT35 (2310-1938)	STANDARD A116C35 (2304-0088) A332C35 (2304-0089) A418C35 (2304-0090) A532C35 (2304-0091) A316C35 (2304-0146)	STANDARD 510HS	<p>TORCHES USED ON: CK510</p>	LONG 300L (57Y02) COLLET CAP 514CCL FOR 1/4" (6.4mm) SHORT 514CCS FOR 1/4" (6.4mm)

• Nose block and collet are not needed when using 1/4" (6.4mm) tungsten.
 • 3 Series head accessories can be used when welding at 400 amps or less

8 SERIES TORCH MODELS 24, 24W

CUP	COLLET BODY	COLLET	HEATSHIELD	TORCH
ALUMINA 8A1 (A53N23) 8A4 (A53N24) 8A5 (A53N25) 8A6 (A53N27)	STANDARD 8CB20 (53N17) 8CB40 (53N18) 8CB116 (53N19) 8CB332 (24CB332)	STANDARD 8C20 (53N15) 8C40 (53N16) 8C116 (53N14) 8C332 (24C332)	STANDARD 80THS	<p>TORCHES USED ON: CK80 CK90 CK180 CWH180 CK24 CK24W</p>
ALUMINA - GAS LENS 2AG4 (53N58) 2AG6 (53N60) 2AG5 (53N59) 2AG7 (53N61)	GAS LENS 2GL20 (45V41) 2GL40 (45V42) 2GL116 (45V43) 2GL332 (45V44)	GAS LENS 8CG20 (53N62) 8CG40 (53N63) 8CG116 (53N64) 8CG332 (24GLC332)	GAS LENS 8GHS	
ALUMINA LONG - GAS LENS 2AG5L (53N59L) 2AG6L (53N60L) 2AG7L (53N61L)		WEDGE 8CG116GS 8CG332GS		
ALUMINA 8A1 (A53N23) 8A4 (A53N24) 8A5 (A53N25) 8A6 (A53N27)	GAS LENS 8GL040 8GL116 8GL332	GAS LENS 8C332 (24C332) 8C040 8C116	GAS LENS 8GHS	

TUNGSTEN ELECTRODE CONVERSION CHART

SIZE SUFFIX	INCHES	MILLIMETERS
20	.020"	.5mm
40	.040"	1.0mm
116	1/16"	1.6mm
332	3/32"	2.4mm
418	1/8"	3.2mm
532	5/32"	4.0mm
316	3/16"	4.8mm
14	1/4"	6.4mm

8C332 Size Suffix

OZMO TORCH MODELS 24, 24W, CK80, CK90, CK180

CUP	GAS LENS	COLLET	HEATSHIELD	TORCH
PSNS8A6	8GL332	PSNS8C332	PSNSHSOZ	<p>TORCHES USED ON: CK24 CK24W CK80 CK90 CK180</p>

CUT-DOWN TORCH MODELS 24, 24W, CK80, CK90, CK180

CUP	GAS LENS	COLLET	HEATSHIELD	TORCH
PSNS2AG75	PSNSGL332	PSNSC332GS	PSNSHS	<p>TORCHES USED ON: CK24 CK24W CK80 CK90 CK180</p>

MICRO TORCH PARTS MODELS MR70, MR140

THREAD PATTERN: 10 x 32

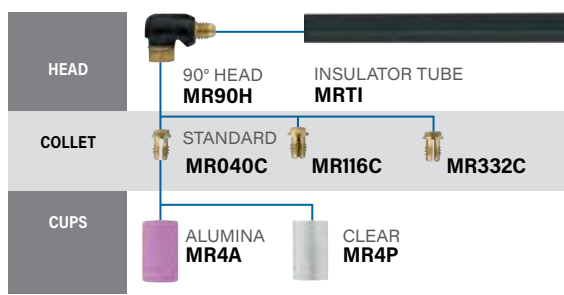

HANDLE BUSHING MRHB

TORCHES USED ON: MR70 MR140



TUNGSTEN STICK OUT GAUGE AND WRENCH ORDER # TGI-24



MICRO TORCH ACCESSORY KIT ORDER # AK-MR

AK-MR kit includes 3 heads (45°, 90° and 180°), 3 collets (1.0, 1.6, and 2.4mm), 3 cups (2 clear and 1 alumina), and 3 pieces of tungsten (1.0, 1.6, and 2.4mm).



MR70 & MR140 PARTS

DESCRIPTION	ORDER #	DESCRIPTION	ORDER #	DESCRIPTION	ORDER #
Head 90°	MR90H	Collet .040" (1.0mm)	MR040C	Cup Alumina	MR4A
Head 45°	MR45H	Collet 1/16" (1.6mm)	MR116C	Cup Clear	MR4P
Head 180°	MR180H	Collet 3/32" (2.4mm)	MR332C	Handle Bushing	MRHB



TUNGSTEN | 2% CERATED

DIAMETER	DIAMETER	REPLACEMENT PART #	ACTUAL SIZE PHOTO	SPECIFICATIONS
.040"	1.0mm	T0409S20GC2		LENGTH 0.9" (22.9mm)
1/16"	1.6mm	T1169S20GC2		GRIND 20°
3/32"	2.4mm	T3329S20GC2		QTY. 5/pkg.

STANDARD MACHINE SERIES

THREAD PATTERN FRONT: 3/8" x 32 REAR: 5/16" x 24

CUP	COLLET BODY	HEATSHIELD	TORCH W/ACM	COLLET	BACKCAP																										
ALUMINA 3A4 (10N50) 3A5 (10N49) 3A6 (10N48) 3A7 (10N47) 3A8 (10N46) 3A10 (10N45) 3A12 (10N44)	STANDARD 3CB20 (10N29) 3CB40 (10N30) 3CB116 (10N31) 3CB332 (10N32) 3CB418 (10N28) 3CB532 (406488)	STANDARD M-HS	TORCHES USED ON: MT100 MT400 MT500* CWMT400* CWMT500*	SHORT 4C20 (10N21S) 4C40 (10N22S) 4C116 (10N23S) 4C332 (10N24S) 4C418 (10N25S) 4C532	LONG AL35 (2304-0145)																										
ALUMINA - GAS LENS 3AG4 (54N18) 3AG7 (54N15) 3AG5 (54N17) 3AG8 (54N14) 3AG6 (54N16) 3AG11 (54N19) 3AG12	GAS LENS 3GL20 (45V29) 3GL40 (45V24) 3GL116 (45V25) 3GL332 (45V26) 3GL418 (45V27) 3GL532 (45V28)	GAS LENS M3G-HS		MEDIUM AM35 (2304-0144)	SHORT AS35 (2304-0143)																										
ALUMINA - LARGE DIAMETER 3AG6LD (57N75) 3AG8LD (57N74) 3AG10LD (53N88) 3AG11LD (53N89) 3AG12LD (53N87)	LARGE DIAMETER 3GL116LD (45V116) 3GL332LD (45V64) 3GL418LD (995795) 3GL532LD (45V63)	LARGE DIAMETER M3G-HSLD		<p>*Contact CK factory for heatshield and backcap part numbers.</p> <h3>TUNGSTEN ELECTRODE CONVERSION CHART</h3> <table border="1"> <thead> <tr> <th>SIZE SUFFIX</th> <th>INCHES</th> <th>MILLIMETERS</th> </tr> </thead> <tbody> <tr> <td>20</td> <td>.020"</td> <td>.5mm</td> </tr> <tr> <td>40</td> <td>.040"</td> <td>1.0mm</td> </tr> <tr> <td>116</td> <td>1/16"</td> <td>1.6mm</td> </tr> <tr> <td>332</td> <td>3/32"</td> <td>2.4mm</td> </tr> <tr> <td>418</td> <td>1/8"</td> <td>3.2mm</td> </tr> <tr> <td>532</td> <td>5/32"</td> <td>4.0mm</td> </tr> <tr> <td>316</td> <td>3/16"</td> <td>4.8mm</td> </tr> <tr> <td>14</td> <td>1/4"</td> <td>6.4mm</td> </tr> </tbody> </table> <p>4C332 Size Suffix</p>		SIZE SUFFIX	INCHES	MILLIMETERS	20	.020"	.5mm	40	.040"	1.0mm	116	1/16"	1.6mm	332	3/32"	2.4mm	418	1/8"	3.2mm	532	5/32"	4.0mm	316	3/16"	4.8mm	14	1/4"
SIZE SUFFIX	INCHES	MILLIMETERS																													
20	.020"	.5mm																													
40	.040"	1.0mm																													
116	1/16"	1.6mm																													
332	3/32"	2.4mm																													
418	1/8"	3.2mm																													
532	5/32"	4.0mm																													
316	3/16"	4.8mm																													
14	1/4"	6.4mm																													

AIRCO A2 SERIES MODELS 10, 20

THREAD PATTERN FRONT: 5/16" x 32 REAR: 1/4" x 28

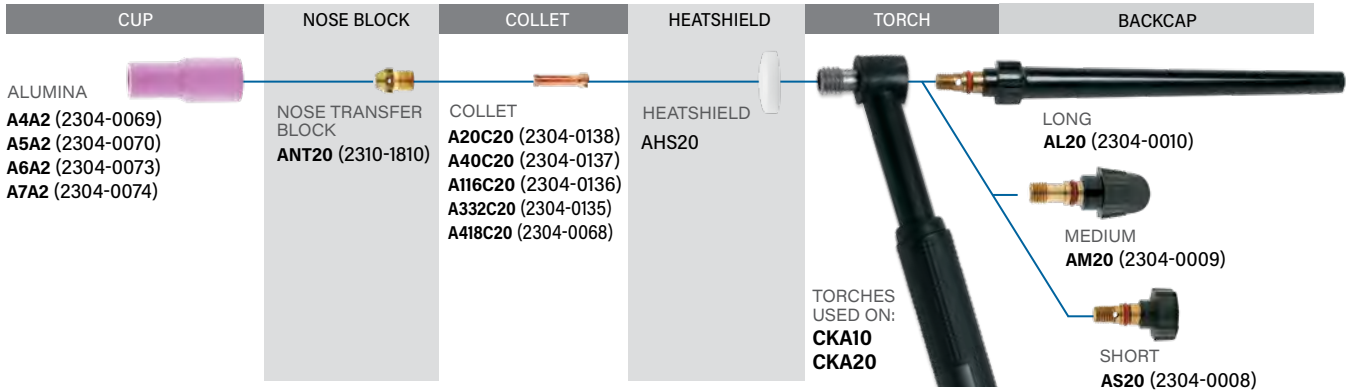

TUNGSTEN ELECTRODE CONVERSION CHART

SIZE SUFFIX	INCHES	MILLIMETERS
20	.020"	.5mm
40	.040"	1.0mm
116	1/16"	1.6mm
332	3/32"	2.4mm
418	1/8"	3.2mm
532	5/32"	4.0mm
316	3/16"	4.8mm
14	1/4"	6.4mm

A332C20 Size Code

AIRCO A3 SERIES MODELS 16, 35

THREAD PATTERN FRONT: 3/8" x 32 REAR: 5/16" x 24

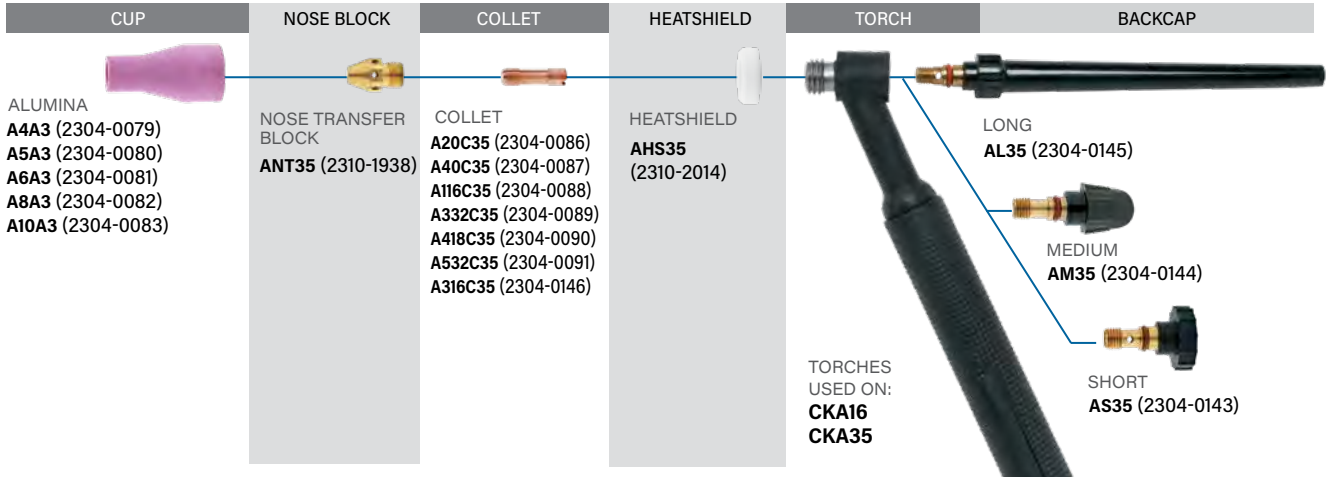

TUNGSTEN ELECTRODE CONVERSION CHART

SIZE SUFFIX	INCHES	MILLIMETERS
20	.020"	.5mm
40	.040"	1.0mm
116	1/16"	1.6mm
332	3/32"	2.4mm
418	1/8"	3.2mm
532	5/32"	4.0mm
316	3/16"	4.8mm
14	1/4"	6.4mm

A332C35 Size Code

Pre-packaged kits containing common consumables for our most popular torches.

2 SERIES TORCHES

- CK9
- CK20
- CK25
- CK100
- CK110
- CK130
- CK200
- CK230
- CKM200
- CKM230
- CKPF130
- CKPF200
- CWH230
- CWM230
- FL130
- FL230

2 SERIES | ORDER #AK-1

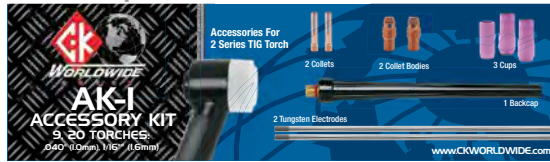

ITEM (Quantity 1 Each)	PART #
Long Backcap	200L (41V24)
.040" (1.0mm) Collet	2C40 (13N21)
1/16" (1.6mm) Collet	2C116 (13N22)
.040" (1.0mm) Collet Body	2CB40 (13N26)
1/16" (1.6mm) Collet Body	2CB116 (13N27)
#4 (1/4" 6.4mm) Alumina Cup	2A4 (13N08)
#5 (5/16" 8.0mm) Alumina Cup	2A5 (13N09)
#6 (3/8" 9.6mm) Alumina Cup	2A6 (13N10)
.040" (1.0mm) x 7" 2% Ceriated Tungsten	T0407GC2
1/16" (1.6mm) x 7" 2% Ceriated Tungsten	T1167GC2

2 SERIES | ORDER #AK-4



ITEM (Quantity 1 Each)	PART #
Long Backcap	200L (41V24)
1/16" (1.6mm) Collet	2C116 (13N22)
3/32" (2.4mm) Collet	2C332 (13N23)
1/8" (3.2mm) Collet	2C418 (13N24)
1/16" (1.6mm) Collet Body	2CB116 (13N27)
3/32" (2.4mm) Collet Body	2CB332 (13N28)
1/8" (3.2mm) Collet Body	2CB418 (13N29)
#5 (5/16" 8.0mm) Alumina Cup	2A5 (13N09)
#6 (3/8" 9.6mm) Alumina Cup	2A6 (13N10)
#8 (1/2" 12.8mm) Alumina Cup	2A8 (13N12)
1/16" (1.6mm) x 7" 2% Ceriated Tungsten	T1167GC2
3/32" (2.4mm) x 7" 2% Ceriated Tungsten	T3327GC2
1/8" (3.2mm) x 7" 2% Ceriated Tungsten	T187GC2

3 SERIES TORCHES

- CK17
- CK18/CK18HD
- CK26/CK26HD
- CK150
- CK210
- CK300
- CK510
- CKC150
- CKM210
- CKM350
- CWH350
- CWHTL300
- CWM350
- FL150
- FL250
- TL18
- TL26
- TL210
- TL300

3 SERIES | ORDER #AK-2



ITEM (Quantity 1 Each)	PART #
Short Backcap	300S (57Y04)
.040" (1.0mm) Collet	3C40 (10N22)
1/16" (1.6mm) Collet	3C116 (10N23)
3/32" (2.4mm) Collet	3C332 (10N24)
.040" (1.0mm) Collet Body	3CB40 (10N30)
1/16" (1.6mm) Collet Body	3CB116 (10N31)
3/32" (2.4mm) Collet Body	3CB332 (10N32)
#4 (1/4" 6.4mm) Alumina Cup	3A4 (10N50)
#5 (5/16" 8.0mm) Alumina Cup	3A5 (10N49)
#6 (3/8" 9.6mm) Alumina Cup	3A6 (10N48)
.040" (1.0mm) x 7" 2% Ceriated Tungsten	T0407GC2
1/16" (1.6mm) x 7" 2% Ceriated Tungsten	T1167GC2
3/32" (2.4mm) x 7" 2% Ceriated Tungsten	T3327GC2

3 SERIES | ORDER #AK-3



ITEM (Quantity 1 Each)	PART #
Long Backcap	300L (57Y02)
Short Backcap	300S (57Y04)
1/16" (1.6mm) Collet	3C116 (10N23)
3/32" (2.4mm) Collet	3C332 (10N24)
1/8" (3.2mm) Collet	3C418 (10N25)
1/16" (1.6mm) Collet Body	3CB116 (10N31)
3/32" (2.4mm) Collet Body	3CB332 (10N32)
1/8" (3.2mm) Collet Body	3CB418 (10N28)
#5 (5/16" 8.0mm) Alumina Cup	3A5 (10N49)
#6 (3/8" 9.6mm) Alumina Cup	3A6 (10N48)
#8 (1/2" 12.8mm) Alumina Cup	3A8 (10N46)
1/16" (1.6mm) x 7" 2% Ceriated Tungsten	T1167GC2
3/32" (2.4mm) x 7" 2% Ceriated Tungsten	T3327GC2
1/8" (3.2mm) x 7" 2% Ceriated Tungsten	T187GC2

STUBBY GAS LENS KITS
4 Series Consumables for 3 Series Torches

LOW AMPERAGE STUBBY | ORDER #SGL-KIT

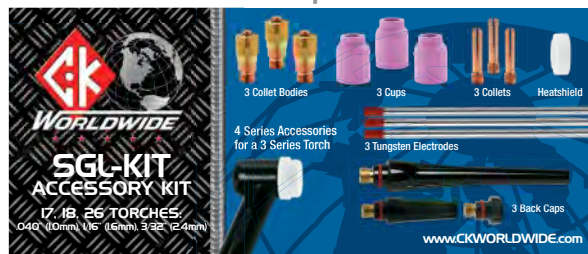

ITEM (Quantity 1 Each)	PART #
BACKCAPS: Short, Medium, and Long	300S / 300M / 300L
.040" (1.0mm) Collet / Gas Lens	4C40 / 4GL40
1/16" (1.6mm) Collet / Gas Lens	4C116 / 4GL116
3/32" (2.4mm) Collet / Gas Lens	4C332 / 4GL332
#5 (5/16" 8.0mm) Alumina Cup	2AG5
#6 (3/8" 9.6mm) Alumina Cup	2AG6
#7 (7/16" 12.8mm) Alumina Cup	2AG7
Heatshield	4GHS
.040" (1.0mm) x 7" 2% Thoriated Tungsten	T0407GT2
1/16" (1.6mm) x 7" 2% Thoriated Tungsten	T1167GT2
3/32" (2.4mm) x 7" 2% Thoriated Tungsten	T3327GT2

HIGH AMPERAGE STUBBY | ORDER #SGL-KITM



ITEM (Quantity 1 Each)	PART #
BACKCAPS: Short, Medium, and Long	300S / 300M / 300L
1/16" (1.6mm) Collet / Gas Lens	4C116 / 4GL116
3/32" (2.4mm) Collet / Gas Lens	4C332 / 4GL332
1/8" (3.2mm) Collet / Gas Lens	4C418 / 4GL418
#6 (3/8" 9.6mm) Alumina Cup	2AG6
#7 (7/16" 12.8mm) Alumina Cup	2AG7
#8 (1/2" 12.8mm) Alumina Cup	2AG8
Heatshield	4GHS
1/8" (3.2mm) x 7" 2% Thoriated Tungsten	T187GT2
3/32" (2.4mm) x 7" 2% Thoriated Tungsten	T3327GT2
1/16" (1.6mm) x 7" 2% Thoriated Tungsten	T1167GT2

2 SERIES GAS SAVER | ORDER #AK-4GS



ITEM (Quantity 1 Each)	PART #
Long Backcap	200L (41V24)
1/16" (1.6mm) Collet	2C116GS
3/32" (2.4mm) Collet	2C332GS
1/8" (3.2mm) Collet	2C418GS
1/16" (1.6mm) Tungsten Adapter	TAS116GS
3/32" (2.4mm) Tungsten Adapter	TAS332GS
1/8" (3.2mm) Tungsten Adapter	TAS418GS
Collet Body	2CBGS-1
Heatshield	2HSGS-1
#4 (1/4" 6.4mm) Alumina Cup	2A4GS
#6 (3/8" 9.6mm) Alumina Cup	2A6GS
#8 (1/2" 12.8mm) Clear Cup	2P8GS
1/16" (1.6mm) x 7" 2% Ceriated Tungsten	T1167GC2
3/32" (2.4mm) x 7" 2% Ceriated Tungsten	T3327GC2
1/8" (3.2mm) x 7" 2% Ceriated Tungsten	T187GC2

2 SERIES TORCHES

CK9
CK20
CK25
CK100
CK110
CK130
CK200
CK230
CKM200
CKM230
CKPF130
CKPF200
CWH230
CWM230
FL130
FL230

3 SERIES GAS SAVER | ORDER #AK-3GS



ITEM (Quantity 1 Each)	PART #
Short Backcap	300S (57Y04)
1/16" (1.6mm) Collet	3C116GS
3/32" (2.4mm) Collet	3C332GS
1/8" (3.2mm) Collet	3C418GS
1/16" (1.6mm) Tungsten Adapter	TAS116GS
3/32" (2.4mm) Tungsten Adapter	TAS332GS
1/8" (3.2mm) Tungsten Adapter	TAS418GS
Collet Body	3CBGS
Heatshield	3HSGS
#5 (5/16" 8.0mm) Alumina Cup	3A5GS
#6 (3/8" 9.6mm) Alumina Cup	3A6GS
#8 (1/2" 12.8mm) Clear Cup	3P8GS
1/16" (1.6mm) x 7" 2% Ceriated Tungsten	T1167GC2
3/32" (2.4mm) x 7" 2% Ceriated Tungsten	T3327GC2
1/8" (3.2mm) x 7" 2% Ceriated Tungsten	T187GC2

8 SERIES TORCHES

CK80
CK90
CK180
CWH180
CK24
CK24W

8 SERIES | ORDER #AK-5



ITEM (Quantity 1 Each)	PART #
.040" (1.0mm) Collet	8C40 (53N16)
1/16" (1.6mm) Collet	8C116 (53N14)
.040" (1.0mm) Collet Body	8CB40 (53N18)
1/16" (1.6mm) Collet Body	8CB116 (53N19)
#4 (1/4" 6.4mm) Ceramic Cup	8C4 (53N24)
#5 (5/16" 8.0mm) Ceramic Cup	8C5 (53N25)
#6 (3/8" 9.6mm) Ceramic Cup	8C6 (53N27)
.040" (1.0mm) x 7" 2% Ceriated Tungsten	T0407GC2
1/16" (1.6mm) x 7" 2% Ceriated Tungsten	T1167GC2

OZMO KIT | ORDER #KIT-OZMO



ITEM	QTY	PART #
3/32" (2.4mm) Collet	2	PSNS8C332
3/32" (2.4mm) Gas Lens	2	8GL332
.38" (9.5mm) Alumina Cup	2	PSNS8A6
Heatshield	1	PSNSHSOZ
3/32" (2.4mm) x 0.9" 2% Ceriated Tungsten - 5 Pack	1	T3329S20GC2

USE OZMO ON TORCHES

CK24
CK24W
CK80
CK90
CK180

CUT DOWN KIT | ORDER #KIT-CD



ITEM	QTY	PART #
3/32" (2.4mm) Collet	2	PSNSC332GS
3/32" (2.4mm) Gas Lens	2	PSNSGL332
.46" (11.8mm) Alumina Cup	2	PSNS2AG75
Heatshield	1	PSNSHS
3/32" (2.4mm) x 0.9" 2% Ceriated Tungsten - 5 Pack	1	T3329S20GC2

USE CUT-DOWN ON TORCHES

CK24
CK24W
CK80
CK90
CK180

FLEX-LOC™ TORCH REPLACEMENT PARTS

FLEX-LOCK HEAD OPTIONS

FL2L
TORCH HEAD
Comes complete with 2GHS heatshield and 01-0009 screw with O-Ring

TORCHES USED ON:
FL130
FL130V
FL230

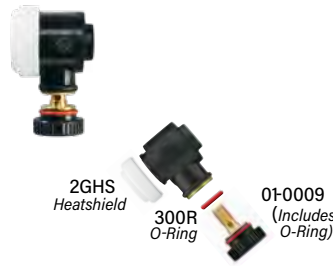

FL3L
TORCH HEAD
Comes complete with 300HS heatshield and 01-0009 screw with O-Ring

TORCHES USED ON:
FL150
FL150V
FL250

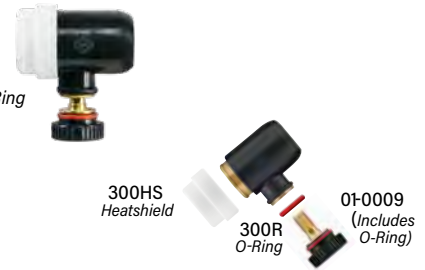

TORCH BODY GAS COOLED

FLTBA
COMPLETE BODY



TORCH BODY GAS COOLED + VALVE

FLTBAV
COMPLETE BODY

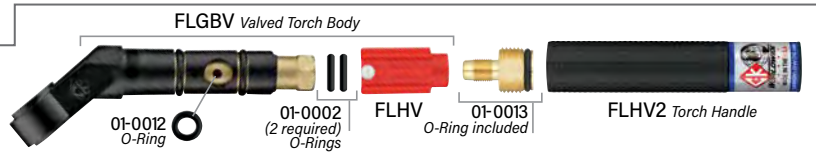

TORCH BODY WATER COOLED

FLTBAW
COMPLETE BODY

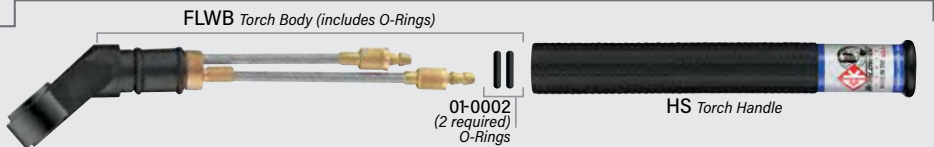

FLEX-LOC 2 SERIES MODELS FL130 & FL230

FL130 & FL130V | GAS COOLED | 130 AMP

DESCRIPTION	ORDER #	DETAILS
2 Series Flex-Loc Head	FL2L	Complete with 2GHS & 01-0009 screw
Heatshield for FL2L	2GHS	
Screw with O-Ring	01-0009	Includes 300R O-ring
Torch Body	FLGB	Includes two O-rings (01-0002)
Valved Torch Body	FLGBV	
Torch Handle	HS	For non-valved torch
Valved Torch Handle	FLHV2	For valved torch
Complete Body	FLTBA	Includes body, handle, and O-rings
Complete Valve Body	FLTBAV	Includes body, valve, handle, & O-rings

FL230 | WATER COOLED | 230 AMP

DESCRIPTION	ORDER #	DETAILS
2 Series Flex-Loc Head	FL2L	Complete with 2GHS & 01-0009 screw
Heatshield for FL2L	2GHS	
Screw with O-Ring	01-0009	Includes 300R O-ring
Torch Body	FLWB	Includes two O-rings (01-0002)
Torch Handle	HS	
Complete Body	FLTBAW	Includes body, handle, and O-rings

FLEX-LOC 3 SERIES MODELS FL150 & FL250

FL150 & FL150V | GAS COOLED | 150 AMP

DESCRIPTION	ORDER #	DETAILS
3 Series Flex-Loc Head	FL3L	Complete with 300HS & 01-0009 screw
Heatshield for FL3L	300HS	
Screw with O-Ring	01-0009	Includes 300R O-ring
Torch Body	FLGB	Includes two O-rings (01-0002)
Valved Torch Body	FLGBV	
Torch Handle	HS	For non-valved torch
Valved Torch Handle	FLHV2	For valved torch
Complete Body	FLTBA	Includes body, handle, and O-rings
Complete Valve Body	FLTBAV	Includes body, valve, handle, & O-rings

FL250 | WATER COOLED | 250 AMP

DESCRIPTION	ORDER #	DETAILS
3 Series Flex-Loc Head	FL3L	Complete with 300HS & 01-0009 screw
Heatshield for FL3L	300HS	
Screw with O-Ring	01-0009	Includes 300R O-ring
Torch Body	FLWB	Includes two O-rings (01-0002)
Torch Handle	HS	
Complete Body	FLTBAW	Includes body, handle, and O-rings

TORCH BODIES

STANDARD

PART #	STYLE
CK9 RG	Rigid
CK9 FX	Flex
CK9P	Pencil
CK17 RG	Rigid
CK17 FX	Flex
CK17P	Pencil
CK17 RG-T	Thread-On
CK18	Rigid
CK18 FX	Flex
CK18P	Pencil
CK20	Rigid
CK20 FX	Flex
CK20P	Pencil
CK24 RG	Rigid
CK24 FX	Flex
CK24W	Rigid
CK25	Pencil Flex
CK26 FX	Flex
CK26 RG	Rigid
CK26P	Pencil
CK80	Rigid
CK90	Flex
CK100	Rigid
CKPF130	Pencil Flex
CK150 RG	Rigid
CK150 FX	Flex
CK180	Rigid
CK210 RG	Rigid
CK210 FX	Flex
CK300	Rigid
CK300 FX	Flex

VALVED

PART #	STYLE
CK9V RG	Valved Rigid
CK9V FX	Valved Flex
CK9PV	Valved Pencil
CK17V RG	Valved Rigid
CK17V FX	Valved Flex
CK17V RG-T	Thread-On
CK18V	Valved Rigid
CK18V FX	Valved Flex
CK20V	Valved Rigid
CK20V FX	Valved Flex
CK24V RG	Valved Rigid
CK24V FX	Valved Flex
CK24WV	Water Valved
CK26V RG	Valved Rigid
CK26V FX	Valved Flex
CK80V	Valved Rigid
CK90V	Valved Flex
CK100V	Valved Rigid
CK210V FX	Valved Flex
CK210V RG	Valved Rigid
CK300V	Valved Rigid
CK300V FX	Valved Flex

MASTER TIG

PART #	STYLE
CK130 FX	Flex
CK130 RG	Rigid
CK200	Rigid
CK200 FX	Flex
CK230	Rigid
CK230 FX	Flex
CK510	Rigid
CKC150	Contractor/ Stainless Steel Head
CKPF200	Pencil Flex
CKT200-116	Rigid
CKT200-332	Rigid
TL18	Rigid
TL18 FX	Flex
TL210 FX	Flex
TL210 RG	Rigid
TL26 FX	Flex
TL26 RG	Rigid
TL300	Rigid
TL300 FX	Flex

VALVED

PART #	STYLE
CK130V RG	Valved Rigid
CK130V FX	Valved Flex
CK150V RG	Valved Rigid
CK200V	Valved Rigid
CK200V FX	Valved Flex
CK230V	Valved Rigid
CK230V FX	Valved Flex
CK510V	Valved Rigid
CKC150V	Contractor/ Stainless Steel Head/Valved
TL18V	Valved Rigid
TL18V FX	Valved Flex
TL210V FX	Valved Flex
TL210V RG	Valved Rigid
TL26V FX	Valved Flex
TL26V RG	Valved Rigid
TL300V	Valved Rigid
TL300V FX	Valved Flex

AIRCO

PART #	STYLE
CKA10	Rigid
CKA16 RG	Rigid
CKA16 FX	Flex
CKA20	Rigid
CKA35	Rigid

AIRCO VALVED

PART #	STYLE
CKA10V	Valved Rigid
CKA16V RG	Valved Rigid
CKA16V FX	Valved Flex
CKA20V	Valved Rigid
CKA35V	Valved Rigid

MACHINE

PART #	STYLE
CKM150	Machine
CKM200	Machine
CKM210	Machine
CKM230	Machine
CKM350	Machine
MT100	Machine
MT400	Machine
MT500C-7	Machine
MT500C-18	Machine

VALVES

PART #	TORCHES USED ON
VKS	CK9, CK20, CK100, CK180, CK200, CK230
VK	CK17, CK18, CK26, CK150, CK210, CK300, CK510, TL18, TL26, TL210, TL300
100VK	CK24, CK24W, CK80, CK90, CK180

TORCH HANDLES

STANDARD

PART #	TORCHES USED ON
HS	CK9, CK20, CK24*, CK24W*, CK25, CK80*, CK90*, CK100, CK130, CKPF130, CK180*, CK200, CKPF200, CKT200, Flex-Locs*, MR70, MR140
HM	CK17, CK150, CKC150*, CKM150
H23	CKA10, CKA20, TL18, TL26, TL210, CK230, TL300
HL	CK18, CK18HD, CK26, CK26HD, CK210, CKM210, CK300, CK510
HA	CKA16, CKA35

SPECIALS

PART #	TORCHES USED ON
9HVR	CK9PV
24WHVR	CK24WV
24HVR	CK24V RG / CK80V
24HVF	CK24V FX / CK90V
180HVR	CK180V
FLHV2	Valved Flex-Locs
150HCVR	CKC150V
17HT	CK17 RG-T

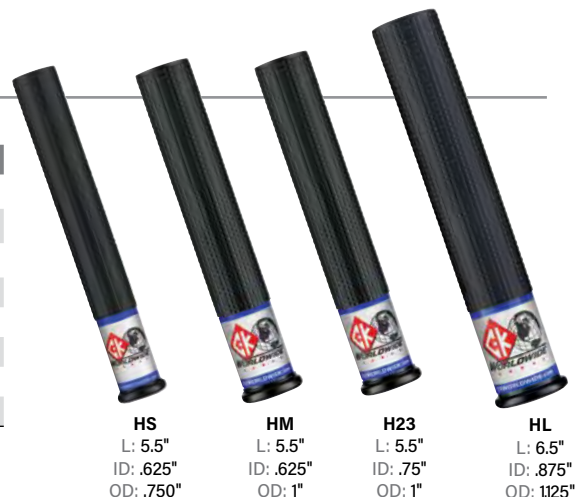

HS L: 5.5" ID: .625" OD: .750"	HM L: 5.5" ID: .625" OD: 1"	H23 L: 5.5" ID: .75" OD: 1"	HL L: 6.5" ID: .875" OD: 1.125"
--	---	---	---

*For valved options see Specials table at right

PHONE: (253) 854.5820 | FAX: (253) 939.1746

TORCH BODIES & HANDLES

ACCESSORIES & PARTS

GAS SAVER™ KITS

SAVE UP TO 40%
of shield gas consumption

TORCHES

MACHINE
TORCHES

AMPERAGE
CONTROLS

CONNECTORS
& CABLES

TUNGSTEN

ACCESSORIES
& PARTS

*Standard Collet
& Collet Body*

*Gas Saver Collet
& Collet Body*

*Turbulent Gas
Flow Pattern*

*Columnar Gas
Flow Pattern*



TRADEMARK NOTICES:

Gas Saver™, Safe-Loc™, Flex-Loc™, Super-Flex™, Trim-Line™, Max-Flo™, Fail-Safe™, Steady-Grip™, and LaYZr™ are trademarks of CK Worldwide Inc.

Phone: 1.800.426.0877 Fax: 1.800.327.5038

CK Worldwide, Inc. PO Box 1636, Auburn, WA 98071 USA

www.CKWORLDWIDE.com

CONNECT WITH US ON:

