

CK WORLDWIDE INC.

WARRANTY: CK Worldwide, Inc. warrants products manufactured by CK Worldwide, Inc. to be free of defects in materials and workmanship. CK Worldwide, Inc. limits this warranty to replacement of the product or parts thereof and excludes liability for injury, property damage or economic loss attributable to product use or misuse. In any event, CK Worldwide, Inc. will only be responsible for its products when used with accessory items manufactured by CK Worldwide, Inc.

INSTALLATION: Before using this torch, - tighten regulator, hose and power cable fittings with proper wrenches. Using small pliers, securely tighten all knurled hose fittings (Slide the torch handle back for access to the torch connections). Purge the regulator and TIG torch with inert gas at 20 cubic feet per hour. Following these steps will ensure contamination free welds. Repeat this procedure whenever torch or regulator fittings have been detached.

CONNECTION DIAGRAM:

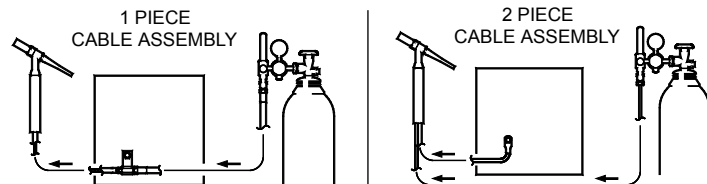

INFORMATION CHART:

Electrode Diameter in inches (mm)	Cup Size	WELDING CURRENT (AMPS) - TUNGSTEN TYPE				ARGON FLOW - FERROUS METALS		ARGON FLOW - ALUMINUM	
		AC Pure	AC Thoriated	DCSP Pure	DCSP Thoriated	Standard Body (Liters)	Gas Lens Body (Liters)	Standard Body (Liters)	Gas Lens Body (Liters)
.020 (0.50)	4 or 5	5 - 15	5 - 20	5 - 15	5 - 20	5-8 (3-4)	5-8 (3-4)	5-8 (3-4)	5-8 (3-4)
.040 (1.00)	4 or 5	10 - 60	15-80	15 - 70	20 - 80	5-10 (3-5)	5-8 (3-4)	5-12 (3-6)	5-10 (3-5)
1/16 (1.60)	4, 5 or 6	50 - 100	70 - 150	70 - 130	80 - 150	7-12 (4-6)	5-10 (3-5)	8-15 (4-7)	7-12 (4-6)
3/32 (2.40)	6, 7 or 8	100 - 160	140 - 235	150 - 220	150 - 250	10-15 (5-7)	8-10 (4-5)	10-20 (5-10)	10-15 (5-7)
1/8 (3.20)	7, 8 or 10	150 - 210	220 - 325	220 - 330	240 - 350	10-18 (5-9)	8-12 (4-6)	12-25 (6-12)	10-20 (5-10)
5/32 (4.00)	8 or 10	200 - 275	300 - 425	375 - 475	400 - 500	15-25 (7-12)	10-15 (5-7)	15-30 (7-14)	12-25 (6-12)
3/16 (4.80)	8 or 10	250 - 350	400 - 525	475-800	475-800	20-35 (10-17)	12-25 (6-12)	25-40 (12-19)	15-30 (7-14)
1/4 (6.40)	10	325 - 700	500 - 700	750 - 1000	700 - 1100	25-50 (12-24)	20-35 (10-17)	30-55 (14-26)	25-45 (12-21)

TUNGSTEN PREPARATION:

END PREPARATION: DCSP (EN)
General Purpose:

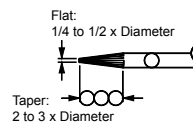

ACHF
General Purpose:

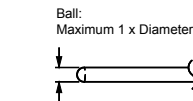

Ball tip by arcing on clean metal at low current DCRP (EP) then slowly increase current to form the desired ball diameter.

GRINDING PREPARATION:
Use a 60 Grit or finer aluminum oxide wheel

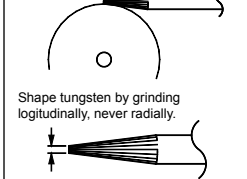

Remove sharp point to leave a truncated point with a flat spot. Diameter of flat spot determines amperage.

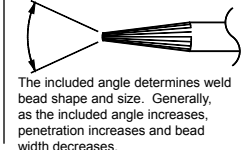

EXTENSION INSTRUCTION: STANDARD PARTS
General Purpose:

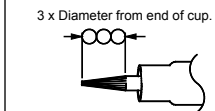

GAS LENS PARTS
General Purpose:

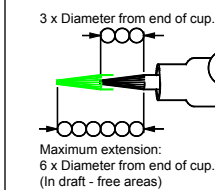

CAUTION:

Personal harm will result from touching the hot parts of a TIG torch without insulative protection, or from looking directly or indirectly at an arc or reflected arc. At no time should bare skin be exposed to a welding arc.



CK9R

TIG TORCH MANUAL



CK9 & CK9V RIGID

TECHNICAL INFORMATION

RATING @ 100% DUTY CYCLE: 125 AMP ACHF OR DCSP
COOLING METHOD: GAS COOLED

ACCESSORY ITEMS REQUIRED FOR COMPLETE INSTALLATION:

HEAD ACCESSORIES: 2 SERIES HEAD ACCESSORIES
POWER CABLE ADAPTOR: 105Z57 (15PCA)

MODEL SELECTOR - TORCH PACKAGES

HEAD STYLE	CABLE STYLE	CABLE LENGTH	STANDARD #	SUPERFLEX #
Rigid Head -w/o valve	2 Piece	12-1/2 ft. (3.8 m)	CK9-12-2	CK9-12-2SF
		25 ft. (7.6 m)	CK9-25-2	CK9-25-2SF
Rigid Head -w/ valve	1 Piece	12-1/2 ft. (3.8 m)	CK9-12-R	CK9-12-RSF
		25 ft. (7.6 m)	CK9-25-R	CK9-25-RSF
Rigid Head -w/ valve	2 Piece	12-1/2 ft. (3.8 m)	CKV9-12-2	CKV9-12-2SF
		25 ft. (7.6 m)	CKV9-25-2	CKV9-25-2SF
Rigid Head -w/ valve	1 Piece	12-1/2 ft. (3.8 m)	CKV9-12-R	CKV9-12-RSF
		25 ft. (7.6 m)	CKV9-25-R	CKV9-25-RSF

IMPORTANT !!
READ AND UNDERSTAND THE INFORMATION CONTAINED IN THIS MANUAL BEFORE OPERATING THE EQUIPMENT !

CK WORLDWIDE INC.
3501 "C" ST. N.E.
AUBURN, WA. 98002
USA

PHONE: (253) 854-5820
PHONE: (800) 426-0877
FAX: (253) 939-1746

www.ckworldwide.com
ck@ckworldwide.com

PARTS:

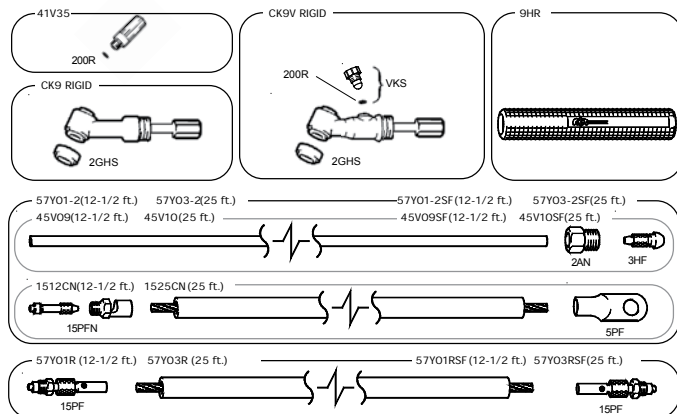

PARTS LIST:

PART NUMBER	DESCRIPTION
CK9 RIGID	TORCH BODY, RIGID, 70 DEGREE, 125 AMP
CK9V RIGID	TORCH BODY WITH VALVE, RIGID, 70 DEGREE, 125 AMP
VKS	GAS VALVE, TOP MOUNTED
9HR	HANDLE
1512CN	POWER CABLE WITH FITTINGS, 12-1/2 FT.
1525CN	POWER CABLE WITH FITTINGS, 25 FT.
57Y01-R	POWER CABLE ASSEMBLY, HI-FLEX 1 PIECE, 12-1/2 FT.
57Y01-RSF	POWER CABLE ASSEMBLY, SUPER FLEX 1 PIECE, 12-1/2 FT.
57Y03-R	POWER CABLE ASSEMBLY, HI-FLEX 1 PIECE, 25 FT.
57R03-RSF	POWER CABLE ASSEMBLY, SUPER FLEX 1 PIECE, 25 FT.
57Y01-2	POWER CABLE ASSEMBLY, HI-PERFORMANCE 2 PIECE, 12-1/2 FT.
57Y01-2SF	POWER CABLE ASSEMBLY, SUPER FLEX 2 PIECE, 12-1/2 FT.
57Y03-2	POWER CABLE ASSEMBLY, HI-PERFORMANCE 2 PIECE, 25 FT.
57Y03-2SF	POWER CABLE ASSEMBLY, SUPER FLEX 2 PIECE, 25 FT.
200R	O-RING
45V09	GAS HOSE WITH FITTINGS, 12-1/2 FT.
45V09SF	GAS HOSE WITH FITTINGS, 12-1/2 FT., SUPER FLEX
45V10	GAS HOSE WITH FITTINGS, 25 FT.
45V10SF	GAS HOSE WITH FITTINGS, 25 FT., SUPER FLEX
2GHS	HEAT SHIELD, STANDARD
200R	O-RING
41V35	BACKCAP, MEDIUM

ACCESSORIES:

PART NUMBER	DESCRIPTION
15PCA (105257)	POWER CABLE ADAPTER
SL2	ONE PIECE POWER CABLE ONLY
SL2-25	TWECO POWER CABLE ADAPTER
SL2-35	DINSE-25 POWER CABLE ADAPTER
SL2-35M	DINSE 35 FLOW-THRU GAS
2AN	POWER CABLE ADAPTER
3HF	ARGON NUT
15PFN	HOSE FITTING
5PF	POWER CABLE FITTING AND NUT
15PF	POWER CABLE FITTING

2 SERIES HEAD ACCESSORIES GAS SAVER

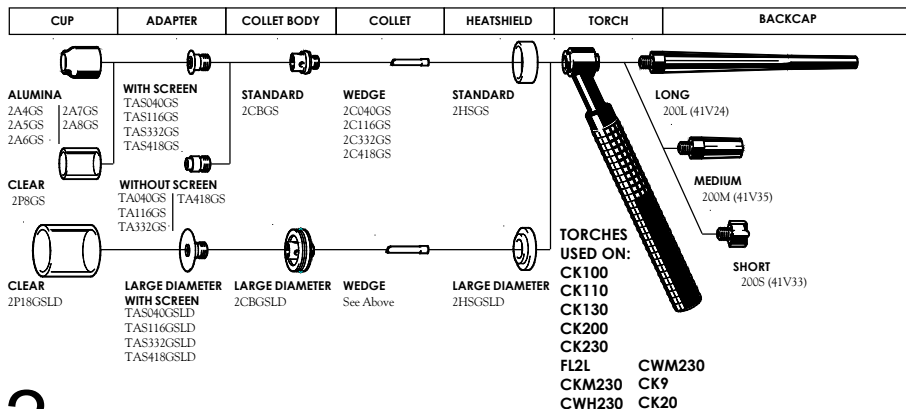

2

2 SERIES HEAD ACCESSORIES

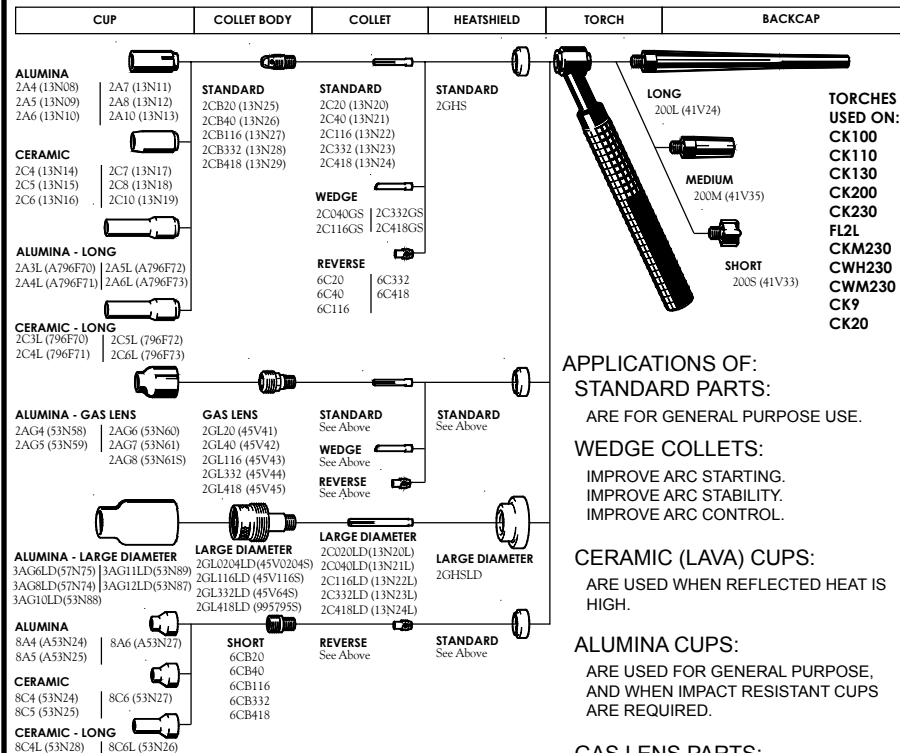

APPLICATIONS OF:
STANDARD PARTS:
ARE FOR GENERAL PURPOSE USE.

WEDGE COLLETS:
IMPROVE ARC STARTING.
IMPROVE ARC STABILITY.
IMPROVE ARC CONTROL.

CERAMIC (LAVA) CUPS:
ARE USED WHEN REFLECTED HEAT IS HIGH.

ALUMINA CUPS:
ARE USED FOR GENERAL PURPOSE,
AND WHEN IMPACT RESISTANT CUPS
ARE REQUIRED.

GAS LENS PARTS:
ARE USED TO REDUCE TURBULENCE
AND IMPROVE SHIELD GAS COVERAGE
PATTERNS,
INCREASES DUTY CYCLE OF TORCH
AND INCREASES TUNGSTEN STICK
OUT.

SHORT (STUBBY) PARTS:
ARE USED TO SHORTEN THE OVERALL
LENGTH OF THE TORCH HEAD.
REDUCES DUTY CYCLE OF TORCH

GAS SAVER® PARTS:
ARE USED TO SAVE UP TO 40% ON GAS
CONSUMPTION.
ARE USED TO SAVE UP TO 60% ON
CONSUMABLE PARTS.
ARE USED TO CLEARLY SEE THE WELD
PUDDLE.
ARE USED TO ACHIEVE GAS LENS

TUNGSTEN ELECTRODE CONVERSION CHART

Size Suffix	Inches	Millimeters
020	.020"	.5mm
040	.040"	1.0mm
116	1/16"	1.6mm
332	3/32"	2.4mm
418	1/8"	3.2mm
532	5/32"	4.0mm

3