



WORLDWIDE



**THE STANDARD
IN TIG WELDING**

TORCH MANUAL

for CK130, CK200, CK230,
FL130, and FL230

2 Series



FORM TM-2MT APRIL 2019

Toll Free: (800) 426.0877

www.CKWORLDWIDE.com

Congratulations on your purchase of a CK Worldwide TIG Torch!

CK Worldwide's premium quality TIG torches perform with a reliability and efficiency you can always depend on. CK equipment and technical support is available online at www.CKWORLDWIDE.com or by calling (800) 426-0877 between 7:00AM and 3:30PM, Monday through Friday.



**THE STANDARD
IN TIG WELDING**

Phone: 1.800.426.0877
Fax: 1.800.327.5083

CK Worldwide, Inc.
PO Box 1636
Auburn, WA 98071 USA

www.CKWORLDWIDE.com

FIND US ON:



Product demonstrations,
welding tips and more.

 **TWITTER:**
@CKWWInc

 **INSTAGRAM:**
@ckworldwide

IN THIS MANUAL

Torch Specifications.....	3
Warranty.....	3

SAFETY INFORMATION

Safety Information.....	4 – 5
-------------------------	-------

TECHNICAL INFORMATION

Torch Connection Diagrams.....	6
Machine Connection Diagrams / Quick Disconnects.....	7

ORDERING INFORMATION

CK130 and CKPF130 130 Amp.....	8 – 9
FL130 130 Amp.....	10 – 11
CK200 and CKPF200 250 Amp.....	12 – 13
CK230 and CKM230 300 Amp.....	14 – 15
FL230 230 Amp.....	16 – 17

2 SERIES CONSUMABLES / GAS SAVER™ KITS

2 Series Standard Parts.....	18
2 Series Gas Saver™ Parts.....	19

ADDITIONAL INFORMATION

Troubleshooting Guide.....	20
----------------------------	----



*Need technical
information? Call
or email to request
a copy of our
Technical Guide
(Form 116)*

The information in this manual represents the best judgement of CK Worldwide, Inc. and is intended for use by experienced personnel. Never operate any equipment without carefully reading, understanding, and following all of the related safety rules and practices. CK Worldwide makes no claims, expressed or implied, as to the viability of this information for any application or use. The individual user is solely responsible for any and all uses of the information contained herein, since CK Worldwide has no means to confirm the correct use of, or control any of the variables to the use of any and all information herein.

IN THIS MANUAL you will find technical and ordering information for CK130, FL130, CK200, CK230, and FL230 TIG torches, hoses, and accessories.

TORCH SPECIFICATIONS

INSTALLATION: Before using this torch, tighten regulator, hose and power cable fittings with proper wrenches. Using small pliers, securely tighten all knurled hose fittings (Slide the torch handle back for access to the torch connections). Purge the regulator and TIG torch with inert gas at 20 cubic feet per hour. Following these steps will ensure contamination free welds. Repeat this procedure whenever torch or regulator fittings have been detached.

CK130



CK200*



CK230



*CKPF200 and CKM200 use the same thread pattern as the CK200.

3/8"-24

MAX-FLO™
Improved Cooling Capacity



1/4"-28

Fail-Safe™
Hose Connectors

3/8"-24 L.H.

FLEX-LOC™ GAS-COOLED



FLEX-LOC™ WATER-COOLED

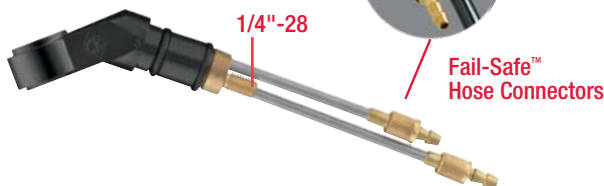

1/8"-28 BSP

1/4"-28

Fail-Safe™
Hose Connectors

WARRANTY: CK Worldwide, Inc. warrants products manufactured by CK Worldwide, Inc. to be free of defects in materials and workmanship. CK Worldwide, Inc. limits this warranty to replacement of the product or parts thereof and excludes liability for injury, property damage or economic loss attributable to product use or misuse. In any event, CK Worldwide, Inc. will only be responsible for its products when used with accessory items manufactured by CK Worldwide, Inc.

CALIFORNIA PROPOSITION 65

WARNING: This product contains or produces a chemical known to the state of California to cause cancer and birth defects or other reproductive harm) (California Health and Safety Code Section 25249.5 et seq.)

WARNING: This product, when used for welding or cutting, produces fumes or gases which contain chemicals known to the State of California to cause birth defects and, in some cases, cancer (California Health and Safety Code Section 25249.5 et seq.)

INFORMATION SOURCES

California Health and Safety Code, Section 25249.4 through 25249.13. The California Office of Environmental Health Hazard Assessment, 301 Capitol Mall, Sacramento, CA 95814; Telephone 916-445-6900.
California Proposition 65 Website: www.oehha.ca.gov/prop65.html.
American National Standards Institute (ANSI). Product Safety Signs And Labels (ANSI Z535.4), available from ANSI, 25 West 43rd Street, New York, NY 10036; Telephone 212-642-4900; Website www.ansi.org.

SAFETY INFORMATION

Welding and cutting equipment can be dangerous to both the operator and people in or near the surrounding working area, if the equipment is not correctly operated. Equipment must only be used under the strict and comprehensive observance of all relevant safety regulations. Read and understand this instruction manual carefully before the installation and operation of this equipment.



ELECTRIC SHOCK:
It can kill



FUMES AND GASES ARE DANGEROUS



ARC RAYS: Harmful to people's eyes and skin



ELECTRIC SHOCK: It can kill. Touching live electrical parts can cause fatal shocks or severe burns. The electrode and work circuit is electrically live whenever the output is on. The input power circuit and internal machine circuits are also live when power is on. Incorrectly installed or improperly grounded equipment is dangerous.

- Connect the primary input cable according to American standards and regulations. ANSI Z49.1.
- Avoid all contact with live electrical parts of the welding circuit, electrodes and wires with bare hands. The operator must wear dry welding gloves while he/she performs the welding task.
- The operator should keep the work piece insulated from himself/herself.
- Keep cords dry, free of oil and grease, and protected from hot metal and sparks.
- Frequently inspect input power cable for wear and tear, replace the cable immediately if damaged, bare wiring is dangerous and can kill.
- Do not use damaged, under-sized, or badly joined cables.
- Do not drape cables over your body.

FUMES AND GASES ARE DANGEROUS: Smoke and gas generated while welding or cutting can be harmful to people's health. Welding produces fumes and gases. Breathing these fumes and gases can be hazardous to your health.

- Do not breathe the smoke and gas generated while welding or cutting, keep your head out of the fumes.
- Keep the working area well ventilated, use fume extraction or ventilation to remove welding fumes and gases.
- In confined or heavy fume environments always wear an approved air-supplied respirator. Welding fumes and gases can displace air and lower the oxygen level causing injury or death. Be certain the air in your work environment is safe to breathe.
- Do not weld in locations near degreasing, cleaning, or spraying operations. The heat and rays of the arc can react with vapors to form highly toxic and irritating gases.
- Materials such as galvanized, lead, or cadmium plated steel, contain elements that can give off toxic fumes when welded. Do not weld these materials unless the area is very well ventilated, and or wearing an air supplied respirator.

ARC RAYS: Harmful to people's eyes and skin. Arc rays from the welding process produce intense visible and invisible ultraviolet and infrared rays that can burn eyes and skin.

- Always wear a welding helmet with correct shade of filter lens and suitable protective clothing including welding gloves while the welding operation is performed.
- Measures should be taken to protect people in or near the surrounding working area. Use protective screens or barriers to protect others from flash, glare and sparks; warn others not to watch the arc.

HOT PARTS: Items being welded generate and hold high heat and can cause severe burns. Do not touch hot parts with bare hands. Allow a cooling period before working on the welding gun. Use insulated welding gloves and clothing to handle hot parts and prevent burns.

FIRE HAZARD: Welding on closed containers, such as tanks, drums, or pipes, can cause them to explode. Flying sparks from the welding arc, hot work piece, and hot equipment can cause fires and burns. Accidental contact of electrode to metal objects can cause sparks, explosion, overheating, or fire. Check and be sure the area is safe before doing any welding.

- Welding sparks may cause fire, therefore remove any flammable materials away from the working area, at least 40 feet (12m) from the welding arc. Cover flammable materials and containers with approved covers if unable to be moved from the welding area.
- Do not weld on closed containers such as tanks, drums, or pipes, unless they are properly prepared according to the required Safety Standards to insure that flammable or toxic vapors and substances are totally removed, these can cause an explosion even though the vessel has been “cleaned.” Vent hollow castings or containers before heating, cutting or welding. They may explode.
- Do not weld where the atmosphere may contain flammable dust, gas, or liquid vapors such as gasoline.
- Have a fire extinguisher nearby and know how to use it. Be alert that welding sparks and hot materials from welding can easily go through small cracks and openings to adjacent areas. Be aware that welding on a ceiling, floor, bulkhead, or partition can cause fire on the hidden side.

GAS CYLINDERS: Shielding gas cylinders contain gas under high pressure. If damaged, a cylinder can explode. Because gas cylinders are normally part of the welding process, be sure to treat them carefully. **CYLINDERS** can explode if damaged.

- Protect gas cylinders from excessive heat, mechanical shocks, physical damage, slag, open flames, sparks, and arcs.
- Insure cylinders are held secure and upright to prevent tipping or falling over.
- Never allow the welding electrode or earth clamp to touch the gas cylinder, do not drape welding cables over the cylinder.
- Never weld on a pressurized gas cylinder, it will explode and kill you.
- Open the cylinder valve slowly and turn your face away from the cylinder outlet valve and gas regulator.

GAS BUILD UP: The build up of gas can cause a toxic environment by depleting the air's oxygen content and potentially resulting in injury or death.

- Shut off shielding gas supply when not in use.
- Always ventilate confined spaces or use approved air-supplied respirator.

ELECTRONIC MAGNETIC FIELDS: **MAGNETIC FIELDS** can affect implanted medical devices.

- Wearers of pacemakers and other implanted medical devices should keep away.
- Implanted medical device wearers should consult their doctor and the device manufacturer before going near any electric welding, cutting or heating operation.

NOISE CAN DAMAGE HEARING: Noise from some processes or equipment can damage hearing. Wear approved ear protection if noise level is high.



FIRE HAZARD



GAS CYLINDERS
Shielding gas cylinders contain gas under high pressure. If damaged, a cylinder can explode



GAS BUILD UP



ELECTRONIC MAGNETIC FIELDS can affect implanted medical devices



NOISE CAN DAMAGE HEARING

CONNECTION DIAGRAMS

GAS-COOLED

2 PIECE



1 PIECE

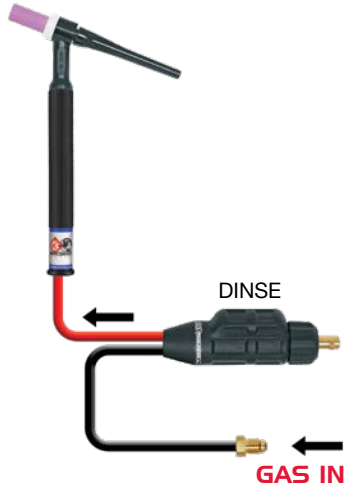

1 PIECE GAS-THRU

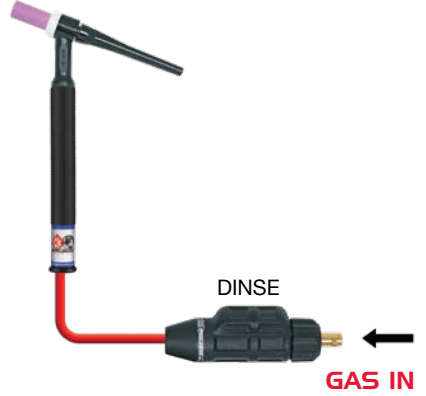

WATER-COOLED

STANDARD

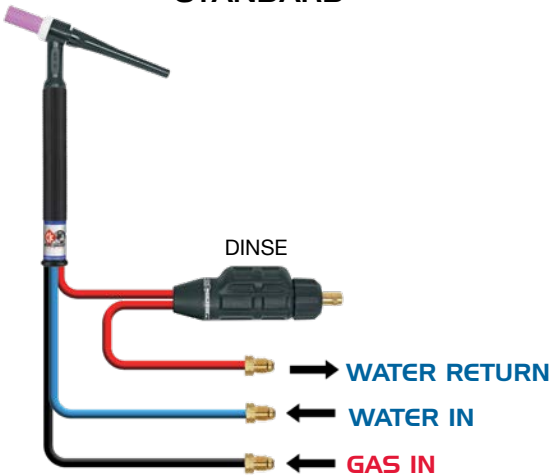

GAS-THRU

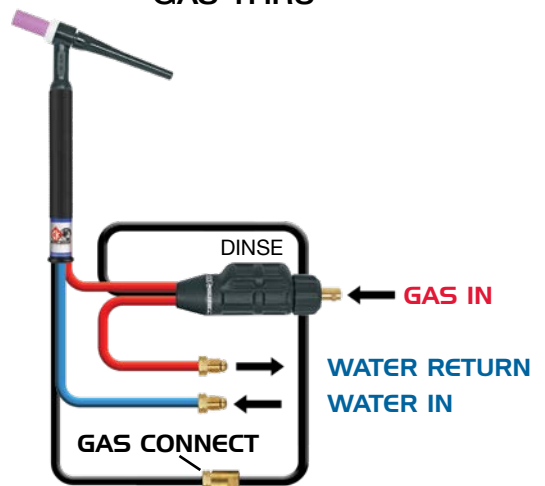

MACHINE CONNECTION DIAGRAMS

1 PIECE GAS-COOLED

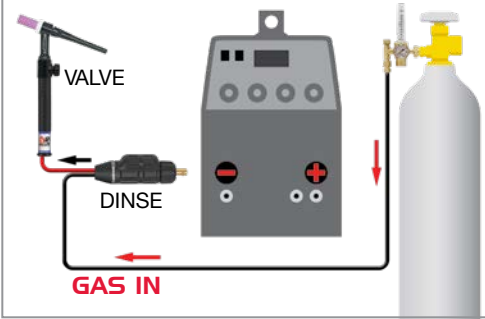

WATER-COOLED

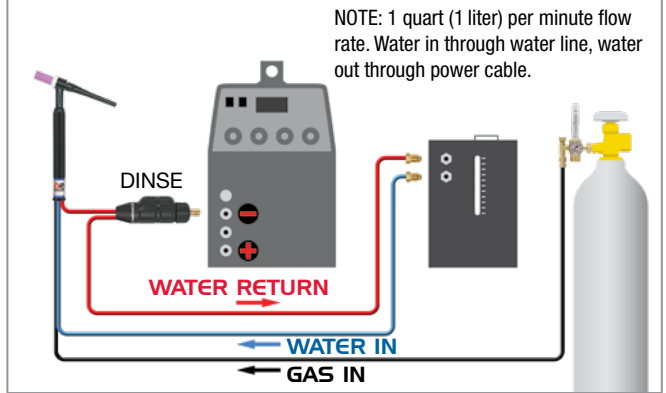

2 PIECE GAS-COOLED

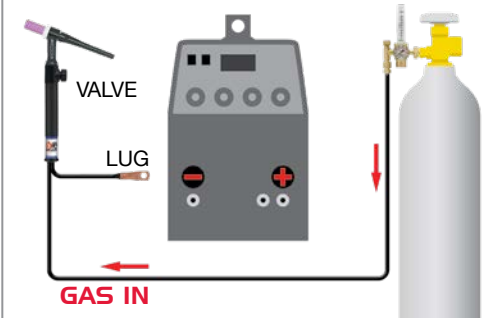

WATER-COOLED GAS-THRU

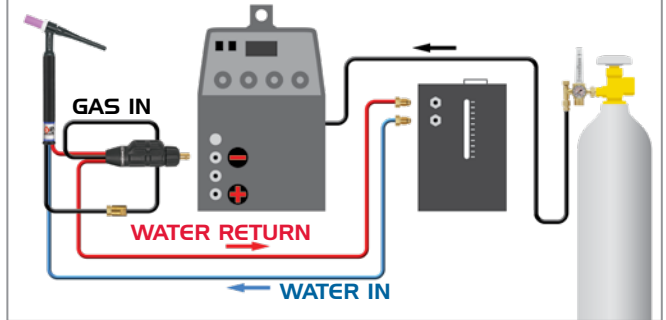

1 PIECE GAS-THRU

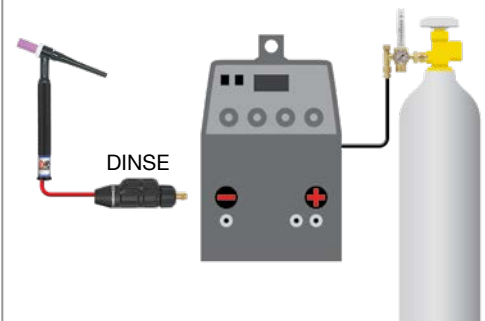

QUICK DISCONNECTS

Adapters for gas-cooled and water-cooled torch setups that have quick-disconnect female adapters on either the machine or water-cooler.

QDWAP

WATER COOLED

9mm male quick disconnect for water.



QDGAP

GAS COOLED

9mm male quick disconnect for argon.



CK130

GAS COOLED
130 amp ACHF or DCSP @ 100%
2 Series Head Accessories

CK130 & CK130V | RIGID

HEAD STYLE	CABLE	CABLE LENGTH	STANDARD #	SUPER-FLEX #	SPECIFICATIONS
RIGID	1 Piece	12.5 ft. (3.8m)	CK1312H RG	CK1312HSF RG	8" (20.3cm) 3-1/2 oz (99gm)
		25 ft. (7.6m)	CK1325H RG	CK1325HSF RG	
	2 Piece	12.5 ft. (3.8m)	CK1312N RG	CK1312NSF RG	
		25 ft. (7.6m)	CK1325N RG	CK1325NSF RG	
RIGID + VALVE	1 Piece	12.5 ft. (3.8m)	CK1312VH RG	CK1312VHSF RG	
		25 ft. (7.6m)	CK1325VH RG	CK1325VHSF RG	
	2 Piece	12.5 ft. (3.8m)	CK1312VN RG	CK1312VNSF RG	
		25 ft. (7.6m)	CK1325VN RG	CK1325VNSF RG	



CK130 RG

CK130 & CK130V | FLEX

HEAD STYLE	CABLE	CABLE LENGTH	STANDARD #	SUPER-FLEX #	SPECIFICATIONS
FLEX	1 Piece	12.5 ft. (3.8m)	CK1312H FX	CK1312HSF FX	8" (20.3cm) 3-1/2 oz (99gm)
		25 ft. (7.6m)	CK1325H FX	CK1325HSF FX	
	2 Piece	12.5 ft. (3.8m)	CK1312N FX	CK1312NSF FX	
		25 ft. (7.6m)	CK1325N FX	CK1325NSF FX	
FLEX + VALVE	1 Piece	12.5 ft. (3.8m)	CK1312VH FX	CK1312VHSF FX	
		25 ft. (7.6m)	CK1325VH FX	CK1325VHSF FX	
	2 Piece	12.5 ft. (3.8m)	CK1312VN FX	CK1312VNSF FX	
		25 ft. (7.6m)	CK1325VN FX	CK1325VNSF FX	

REPLACEMENT TORCH BODIES

PART #	STYLE
CK130 RG	RIGID
CK130 FX	FLEX
CK130V RG	VALVED RIGID
CK130V FX	VALVED FLEX



CK130 RG

CK130 FX

CK130V RG

CK130V FX

CKPF130

GAS COOLED
130 amp ACHF or DCSP @ 100%
2 Series Head Accessories

CKPF130 | PENCIL FLEX

HEAD STYLE	CABLE	CABLE LENGTH	STANDARD #	SUPER-FLEX #	SPECIFICATIONS
FLEX	1 Piece	12.5 ft. (3.8m)	CKPF1312H	CKPF1312HSF	11" (27.9cm)
		25 ft. (7.6m)	CKPF1325H	CKPF1325HSF	3 oz (85gm)



6" (15.2cm) Neck



CKPF130

POWER CABLES/HOSES

1 PIECE STANDARD POWER CABLE



1 PIECE SUPER-FLEX POWER CABLE



2 PIECE STANDARD POWER CABLE



2 PIECE SUPER-FLEX POWER CABLE



LENGTH	STANDARD	SUPER-FLEX
	1 PIECE CABLE	1 PIECE CABLE
12-1/2 ft. (3.8m)	1512PCHF (57Y01R)	1512PCSF (57Y01RSF)
25 ft. (7.6m)	1525PCHF (57Y03R)	1525PCSF (57Y03RSF)

LENGTH	2 PIECE CABLES	2 PIECE CABLES
	12-1/2 ft. (3.8m)	1512PCN (57Y01-2)
25 ft. (7.6m)	1525PCN (57Y03-2)	1525PCNSF (57Y03-2SF)

LENGTH	WELD LEAD
12-1/2 ft. (3.8m)	1512CN
25 ft. (7.6m)	1525CN

LENGTH	ARGON HOSE	ARGON HOSE
12-1/2 ft. (3.8m)	212AH (45V09)	212AHSF (45V09SF)
25 ft. (7.6m)	225AH (45V10)	225AHSF (45V10SF)

POWER CABLE ADAPTER

15PCA | 105Z57



HANDLE Part # HS



DINSE CONNECTORS

DINSE 25
(3/8" 9.5mm)



DINSE 35
(1/2" 12.8mm)



DINSE 25M
(3/8" 9.5mm)



DINSE 35M
(1/2" 12.8mm)

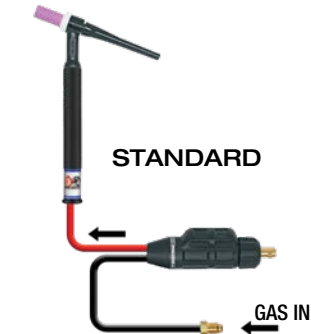

STANDARD

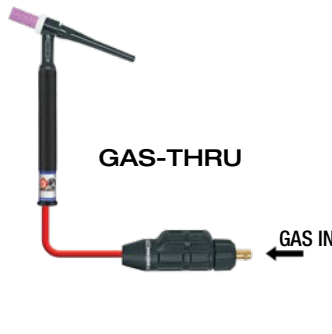

GAS-THRU



TWECO OR CAM-LOCK

STANDARD

DINSE SIZE	ORDER #
3/8" (9mm)	SL2-25
1/2" (12.8mm)	SL2-35

GAS-THRU

DINSE SIZE	ORDER #
3/8" (9mm)	SL2-25M
1/2" (12.8mm)	SL2-35M

TWECO / CAM-LOCK







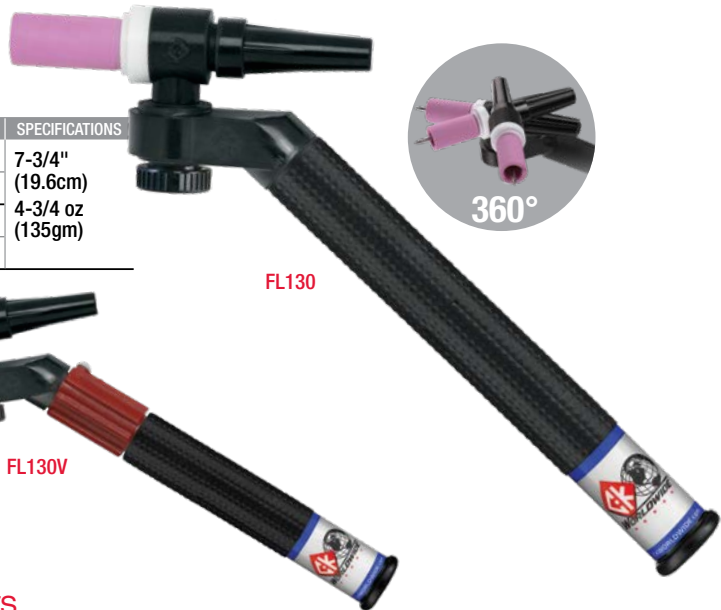







DINSE STYLE	ORDER #
TWECO	SL-2
CAM-LOCK	SL2-CL

FL130 & FL130V | FLEX-LOC

HEAD STYLE	CABLE	CABLE LENGTH	STANDARD #	SUPER-FLEX #	SPECIFICATIONS
FL2L	1 Piece	12.5 ft. (3.8m)	FL1312	FL1312SF	7-3/4" (19.6cm)
		25 ft. (7.6m)	FL1325	FL1325SF	
FL2L + VALVE	1 Piece	12.5 ft. (3.8m)	FL1312V	FL1312VSF	4-3/4 oz (135gm)
		25 ft. (7.6m)	FL1325V	FL1325VSF	



FL130 & FL130V | REPLACEMENT PARTS

FLEX-LOCK HEAD OPTIONS	<p>FL2L TORCH HEAD <i>Comes complete with 2GHS heatshield and 01-0009 screw with O-Ring</i></p> 	<p>2GHS Heatshield</p> 	<p>300R O-Ring</p> 	<p>01-0009 (Includes O-Ring)</p> 			
TORCH BODY GAS COOLED	<p>FLTBA COMPLETE BODY</p> 	<p>FLGB Torch Body</p> 	<p>01-0002 (2 required) O-Rings</p> 	<p>HS Torch Handle</p> 			
TORCH BODY GAS COOLED + VALVE	<p>FLTBAV COMPLETE BODY</p> 	<p>FLGBV Valved Torch Body</p> 	<p>01-0012 O-Ring (2 required)</p> 	<p>01-0002 O-Rings (2 required)</p> 	<p>FLHV</p> 	<p>01-0013 O-Ring included</p> 	<p>FLHV2 Torch Handle</p> 

DESCRIPTION	ORDER #	DETAILS
2 Series Flex-Loc Head	FL2L	Complete with 2GHS & 01-0009 screw
Heatshield for FL2L	2GHS	
Screw with O-Ring	01-0009	Includes 300R O-ring
Torch Body	FLGB	Includes two O-rings (01-0002)
Valved Torch Body	FLGBV	

DESCRIPTION	ORDER #	DETAILS
Torch Handle	HS	For non-valved torch
Valved Torch Handle	FLHV2	For valved torch
Complete Body	FLTBA	Includes body, handle, and O-rings
Complete Valve Body	FLTBAV	Includes body, valve, handle, & O-rings

POWER CABLES/HOSES

1 PIECE STANDARD POWER CABLE



1 PIECE SUPER-FLEX POWER CABLE



LENGTH	STANDARD	SUPER-FLEX
	1 PIECE CABLE	1 PIECE CABLE
12-1/2 ft. (3.8m)	1512PCHFM	1512PCSFM
25 ft. (7.6m)	1525PCHFM	1525PCSFM

POWER CABLE ADAPTER

15PCA | 105Z57

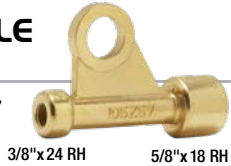

HANDLE

Part # HS



Part # FLHV2



DINSE CONNECTORS

DINSE 25
(3/8" 9.5mm)



DINSE 35
(1/2" 12.8mm)



DINSE 25M
(3/8" 9.5mm)



DINSE 35M
(1/2" 12.8mm)

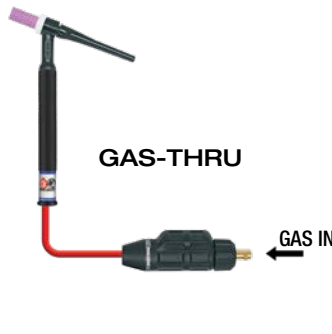
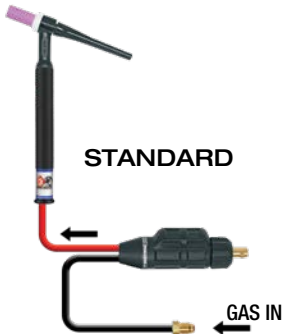

STANDARD

DINSE SIZE	ORDER #
3/8" (9mm)	SL2-25
1/2" (12.8mm)	SL2-35

GAS-THRU

DINSE SIZE	ORDER #
3/8" (9mm)	SL2-25M
1/2" (12.8mm)	SL2-35M

TWECO / CAM-LOCK

DINSE STYLE	ORDER #
TWECO	SL-2
CAM-LOCK	SL2-CL

CK200

WATER COOLED | **SAME AS CK20**
250 amp ACHF or DCSP @ 100%
2 Series Head Accessories

CK200 & CK200V | RIGID

HEAD STYLE	CABLE	CABLE LENGTH	TRI-FLEX #	SUPER-FLEX #	SPECIFICATIONS
RIGID	Tri-Flex/ SUPER-FLEX	12.5 ft. (3.8m)	CK212	CK212SF	7-1/2" (19.0cm)
		25 ft. (7.6m)	CK225	CK225SF	
RIGID + VALVE	Tri-Flex/ SUPER-FLEX	12.5 ft. (3.8m)	CK212V	CK212VSF	3 oz (85gm)
		25 ft. (7.6m)	CK225V	CK225VSF	



CK200 & CK200V | FLEX

HEAD STYLE	CABLE	CABLE LENGTH	TRI-FLEX #	SUPER-FLEX #	SPECIFICATIONS
FLEX	Tri-Flex/ SUPER-FLEX	12.5 ft. (3.8m)	CK212 FX	CK212SF FX	7-1/2" (19.0cm)
		25 ft. (7.6m)	CK225 FX	CK225SF FX	
FLEX + VALVE	Tri-Flex/ SUPER-FLEX	12.5 ft. (3.8m)	CK212V FX	CK212VSF FX	3 oz (85gm)
		25 ft. (7.6m)	CK225V FX	CK225VSF FX	

CK200 RIGID | EXTRA LENGTH SERIES

HEAD STYLE	CABLE	CABLE LENGTH	TRI-FLEX #	SUPER-FLEX #
LONG HEAD 4-1/2" Neck	TriFlex/ SUPER-FLEX	12.5 ft. (3.8m)	CKL212	CKL212SF
		25 ft. (7.6m)	CKL225	CKL225SF
X-LONG HEAD 7-1/2" Neck	TriFlex/ SUPER-FLEX	12.5 ft. (3.8m)	CKXL212	CKXL212SF
		25 ft. (7.6m)	CKXL225	CKXL225SF
XX-LONG HEAD 11-1/2" Neck	TriFlex/ SUPER-FLEX	12.5 ft. (3.8m)	CKXXL212	CKXXL212SF
		25 ft. (7.6m)	CKXXL225	CKXXL225SF

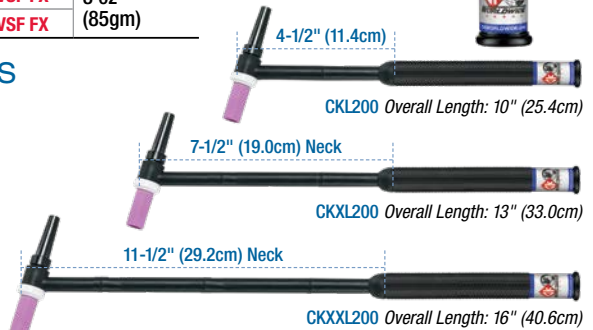

REPLACEMENT TORCH BODIES

PART #	STYLE	PART #	STYLE
CK200 RG	RIGID	CKL200	4-1/2" RIGID
CK200 FX	FLEX	CKXL200	7-1/2" RIGID
CK200V	VALVED RIGID	CKXXL200	11-1/2" RIGID
CK200V FX	VALVED FLEX		



CKPF200

GAS COOLED
250 amp ACHF or DCSP @ 100%
2 Series Head Accessories

CKPF200 | PENCIL FLEX

HEAD STYLE	CABLE	CABLE LENGTH	TRI-FLEX #	SUPER-FLEX #	SPECIFICATIONS
FLEX	Tri-Flex/ SUPER-FLEX	12.5 ft. (3.8m)	CKPF212	CKPF212SF	11-1/2" (29.2cm)
		25 ft. (7.6m)	CKPF225	CKPF225SF	



POWER CABLES/HOSES

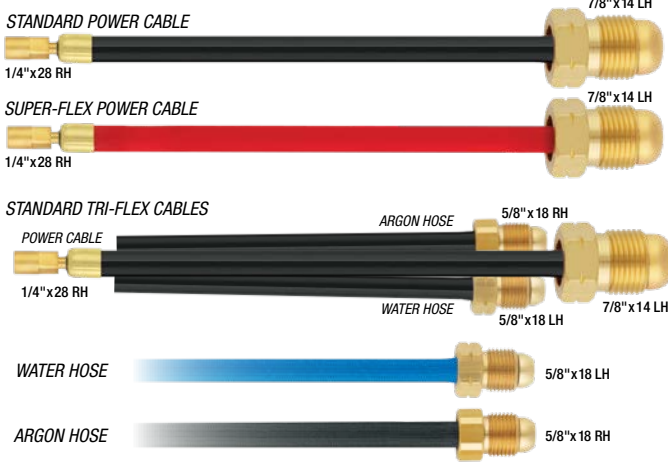

LENGTH	STANDARD	SUPER-FLEX
	POWER CABLE	POWER CABLE
12-1/2 ft. (3.8m)	212PC (45V03)	212PCSF (45V03SF)
25 ft. (7.6m)	225PC (45V04)	225PCSF (45V04SF)

LENGTH	TRI-FLEX CABLES	3-PIECE ASSEMBLY
	12-1/2 ft. (3.8m)	212TF
25 ft. (7.6m)	225TF	225SF

LENGTH	WATER HOSE	WATER HOSE
	12-1/2 ft. (3.8m)	212WH (45V07)
25 ft. (7.6m)	225WH (45V08)	225WHSF (45V08SF)

LENGTH	ARGON HOSE	ARGON HOSE
	12-1/2 ft. (3.8m)	212AH (45V09)
25 ft. (7.6m)	225AH (45V10)	225AHSF (45V10SF)

POWER CABLE ADAPTER

2PCA | 45V11 | 7/8"-14 LH | 5/8"-18 LH

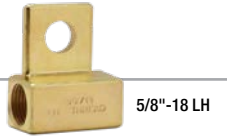

HANDLE Part # HS



DINSE CONNECTORS

DINSE 25
(3/8" 9.5mm)



DINSE 35
(1/2" 12.8mm)



DINSE 25M
(3/8" 9.5mm)



DINSE 35M
(1/2" 12.8mm)

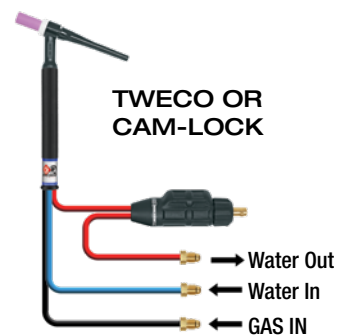
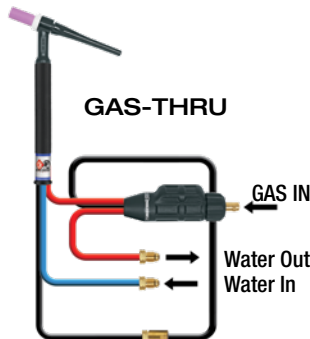
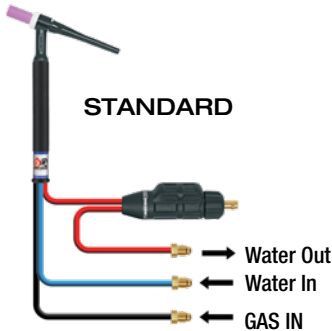

STANDARD

DINSE SIZE	ORDER #
3/8" (9mm)	SLWHAT-25
1/2" (12.8mm)	SLWHAT-35

GAS-THRU

DINSE SIZE	ORDER #
3/8" (9mm)	SLWHAT-25M
1/2" (12.8mm)	SLWHAT-35M

TWECO / CAM-LOCK

DINSE STYLE	ORDER #
TWECO	SLWHAT-T
CAM-LOCK	SLWHAT-CL

CK230

WATER COOLED
300 amp ACHF or DCSP @ 100%
2 Series Head Accessories

CK230 & CK230V | HEAVY DUTY

HEAD STYLE	CABLE	CABLE LENGTH	TRI-FLEX #	SUPER-FLEX #	SPECIFICATIONS
RIGID	Tri-Flex/ SUPER-FLEX	12.5 ft. (3.8m)	CK2312	CK2312SF	8-1/4" (20.9cm)
		25 ft. (7.6m)	CK2325	CK2325SF	
RIGID + VALVE	Tri-Flex/ SUPER-FLEX	12.5 ft. (3.8m)	CK2312V	CK2312VSF	3-3/4 oz (106gm)
		25 ft. (7.6m)	CK2325V	CK2325VSF	



CK230 RG

CK230 & CK230V | FLEX | HEAVY DUTY

HEAD STYLE	CABLE	CABLE LENGTH	TRI-FLEX #	SUPER-FLEX #	SPECIFICATIONS
FLEX	Tri-Flex/ SUPER-FLEX	12.5 ft. (3.8m)	CK2312 FX	CK2312SF FX	8-1/4" (20.9cm)
		25 ft. (7.6m)	CK2325 FX	CK2325SF FX	
FLEX + VALVE	Tri-Flex/ SUPER-FLEX	12.5 ft. (3.8m)	CK2312V FX	CK2312VSF FX	3-3/4 oz (106gm)
		25 ft. (7.6m)	CK2325V FX	CK2325VSF FX	

REPLACEMENT TORCH BODIES

PART #	STYLE
CK230	RIGID
CK230 FX	FLEX
CK230V	VALVED RIGID
CK230V FX	VALVED FLEX



BARREL MACHINE TORCH FRONT LOADING ONLY

CKM230

WATER COOLED
300 amp ACHF or DCSP @ 100%
2 Series Head Accessories

CKM230 | WATER COOLED | 300 AMP

HEAD STYLE	CABLE	CABLE LENGTH	STANDARD#	SUPER-FLEX#	SPECIFICATIONS
BARREL STYLE	3 Piece	12.5 ft. (3.8m)	CKM2312	CKM2312SF	14" (35.6cm) 6 oz (170gm) 1-3/8" (35mm) O.D. Barrel 2 Series Head Accessories
		25 ft. (7.6m)	CKM2325	CKM2325SF	



HR-24 or HR-32 pitch rack available on request.

The CKM230 comes with a 1-3/8" (35mm) O.D. x 12" (30.5cm) high temperature phenolic resin handle as standard.

CK230/CKM230

POWER CABLES/HOSES

STANDARD POWER CABLE



SUPER-FLEX POWER CABLE



STANDARD TRI-FLEX CABLES



ARGON HOSE



WATER HOSE



LENGTH	STANDARD	SUPER-FLEX
	POWER CABLE	POWER CABLE
12-1/2 ft. (3.8m)	2312PC	2312PCSF
25 ft. (7.6m)	2325PC	2325PCSF

LENGTH	TRI-FLEX CABLES	3-PIECE ASSEMBLY
	12-1/2 ft. (3.8m)	2312TF
25 ft. (7.6m)	2325TF	2325SF

LENGTH	WATER HOSE	WATER HOSE
	12-1/2 ft. (3.8m)	212WH (45V07)
25 ft. (7.6m)	225WH (45V08)	225WHSF (45V08SF)

LENGTH	ARGON HOSE	ARGON HOSE
	12-1/2 ft. (3.8m)	212AH (45V09)
25 ft. (7.6m)	225AH (45V10)	225AHSF (45V10SF)

POWER CABLE ADAPTER

2PCA | 45V11 7/8"-14 LH

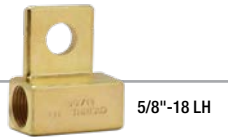

5/8"-18 LH

HANDLE Part # H23



DINSE CONNECTORS

DINSE 25
(3/8" 9.5mm)



DINSE 35
(1/2" 12.8mm)



DINSE 25M
(3/8" 9.5mm)



DINSE 35M
(1/2" 12.8mm)

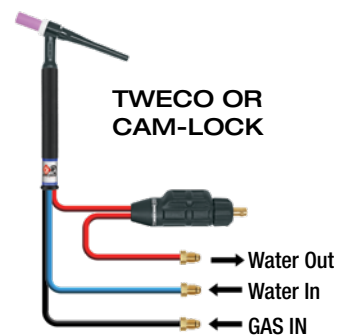
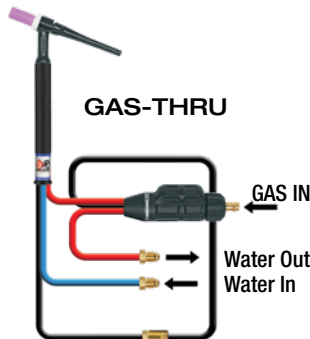
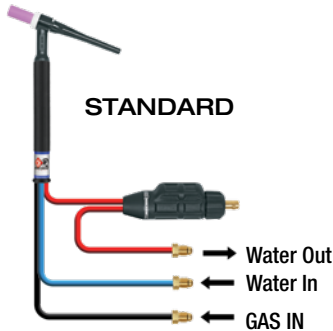

STANDARD

DINSE SIZE	ORDER #
3/8" (9mm)	SLWHAT-25
1/2" (12.8mm)	SLWHAT-35

GAS-THRU

DINSE SIZE	ORDER #
3/8" (9mm)	SLWHAT-25M
1/2" (12.8mm)	SLWHAT-35M

TWECO / CAM-LOCK

DINSE STYLE	ORDER #
TWECO	SLWHAT-T
CAM-LOCK	SLWHAT-CL

FL230



WATER COOLED
230 amp ACHF or DCSP @ 100%
2 Series Head Accessories

FL230 | FLEX-LOC

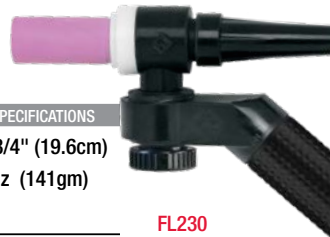
HEAD STYLE	CABLE	CABLE LENGTH	TRI-FLEX #	SUPER-FLEX #	SPECIFICATIONS
FL2L	Tri-Flex/ SUPER-FLEX	12.5 ft. (3.8m)	FL2312	FL2312SF	7-3/4" (19.6cm)
		25 ft. (7.6m)	FL2325	FL2325SF	5 oz (141gm)

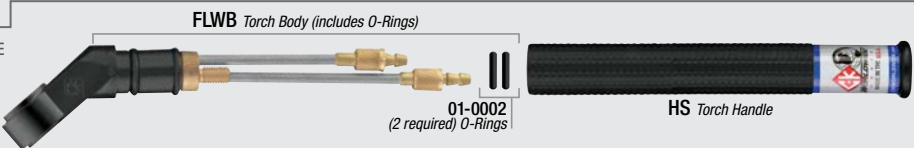

FL230 & FL230V | REPLACEMENT PARTS

FLEX-LOCK HEAD	<p>FL2L TORCH HEAD <i>Comes complete with 2GHS heatshield and 01-0009 screw with O-Ring</i></p> 	<p>2GHS Heatshield</p> 	<p>01-0009 (Includes O-Ring)</p> 
TORCH BODY WATER COOLED	<p>FLTBAW COMPLETE BODY</p> 		

DESCRIPTION	ORDER #	DETAILS
2 Series Flex-Loc Head	FL2L	Complete with 2GHS & 01-0009 screw
Heatshield for FL2L	2GHS	
Screw with O-Ring	01-0009	Includes 300R O-ring

DESCRIPTION	ORDER #	DETAILS
Torch Body	FLWB	Includes two O-rings (01-0002)
Torch Handle	HS	
Complete Body	FLTBAW	Includes body, handle, and O-rings

POWER CABLES/HOSES

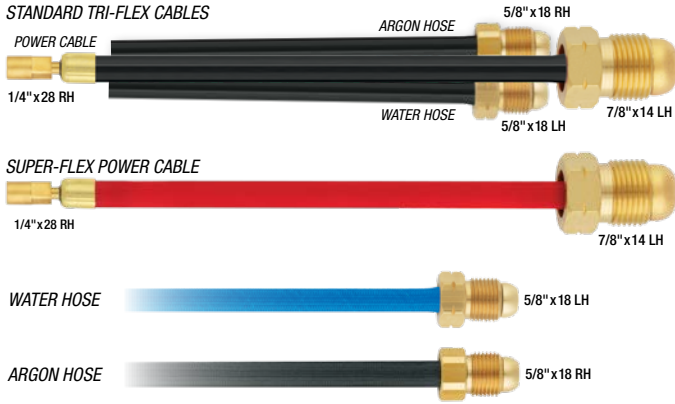

	STANDARD	SUPER-FLEX
	TRI-FLEX CABLES	3-PIECE ASSEMBLY
LENGTH		
12-1/2 ft. (3.8m)	212TF	212SF
25 ft. (7.6m)	225TF	225SF
	POWER CABLE	POWER CABLE
LENGTH		
12-1/2 ft. (3.8m)	212PC	212PCSF
25 ft. (7.6m)	225PC	225PCSF
	WATER HOSE	WATER HOSE
LENGTH		
12-1/2 ft. (3.8m)	212WH	212WHSF
25 ft. (7.6m)	225WH	225WHSF
	ARGON HOSE	ARGON HOSE
LENGTH		
12-1/2 ft. (3.8m)	212AH	212AHSF
25 ft. (7.6m)	225AH	225AHSF

POWER CABLE ADAPTER

2PCA | 45V11 | 7/8"-14 LH | 5/8"-18 LH



HANDLE Part # HS



DINSE CONNECTORS

DINSE 25
(3/8" 9.5mm)



DINSE 35
(1/2" 12.8mm)



DINSE 25M
(3/8" 9.5mm)



DINSE 35M
(1/2" 12.8mm)

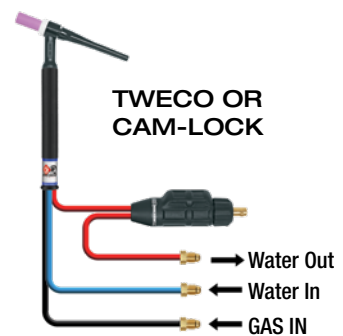
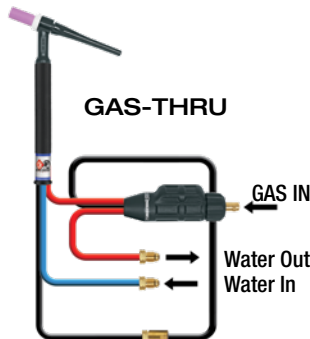
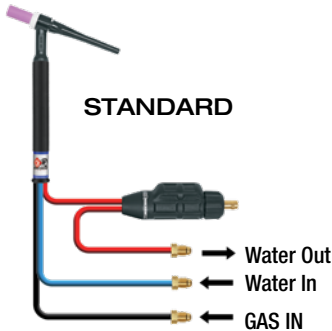

STANDARD

DINSE SIZE	ORDER #
3/8" (9mm)	SLWHAT-25
1/2" (12.8mm)	SLWHAT-35

GAS-THRU

DINSE SIZE	ORDER #
3/8" (9mm)	SLWHAT-25M
1/2" (12.8mm)	SLWHAT-35M

TWECO / CAM-LOCK

DINSE STYLE	ORDER #
TWECO	SLWHAT-T
CAM-LOCK	SLWHAT-CL

2 SERIES PARTS (13N) TORCH MODELS 9, 20

THREAD PATTERN: 5/16" x 24

CUP	COLLET BODY	COLLET	HEATSHIELD	TORCH	BACKCAP
ALUMINA 2A4 (13N08) 2A5 (13N09) 2A6 (13N10)	2A7 (13N11) 2A8 (13N12) 2A10 (13N13)	STANDARD 2C20 (13N20) 2C40 (13N21) 2C116 (13N22) 2C332 (13N23) 2C418 (13N24)	STANDARD 2GHS	<p>TORCHES USED ON: CK100 CK110 CK130 CK200 CK230 FL2L CKM230 CWH230 CWM230 CK9 CK20 CK25</p>	LONG 200L (41V24)
CERAMIC 2C4 (13N14) 2C5 (13N15) 2C6 (13N16)	2C7 (13N17) 2C8 (13N18) 2C10 (13N19)	WEDGE 2C040GS 2C332GS 2C116GS 2C418GS			MEDIUM 200M (41V35)
ALUMINA - LONG 2A3L (A796F70) 2A5L (A796F72) 2A4L (A796F71) 2A6L (A796F73)		REVERSE 6C20 6C332 6C40 6C418 6C116			SHORT 200S (41V33)
CERAMIC - LONG 2C3L (796F70) 2C5L (796F72) 2C4L (796F71) 2C6L (796F73)					
ALUMINA - GAS LENS 2AG4 (53N58) 2AG7 (53N61) 2AG5 (53N59) 2AG8 (53N61S) 2AG6 (53N60) 2AG10	GAS LENS 2GL20 (45V41) 2GL40 (45V42) 2GL116 (45V43) 2GL332 (45V44) 2GL418 (45V45)	STANDARD SEE ABOVE WEDGE SEE ABOVE REVERSE SEE ABOVE	STANDARD SEE ABOVE		
ALUMINA LONG - GAS LENS 2AG5L (53N59L) 2AG7L (53N61L) 2AG6L (53N60L)					
ALUMINA - LARGE DIAMETER 3AG6LD (57N75) 3AG11LD(53N89) 3AG8LD (57N74) 3AG12LD(53N87) 3AG10LD (53N88)	LARGE DIAMETER 2GL0204LD (45V0204S) 2GL116LD (45V116S) 2GL332LD (45V64S) 2GL418LD (995795S)	LARGE DIAMETER 2C020LD (13N20L) 2C040LD (13N21L) 2C116LD (13N22L) 2C332LD (13N23L) 2C418LD (13N24L)	LARGE DIAMETER 2GHSLD		
ALUMINA 8A4 (A53N24) 8A5 (A53N25)	SHORT 6CB20 6CB40 6CB116 6CB332 6CB418	REVERSE SEE ABOVE	STANDARD SEE ABOVE		
CERAMIC 8C4 (53N24) 8C5 (53N25)	8C6 (53N27)				
CERAMIC - LONG 8C4L (53N28) 8C6L (53N26)					

TUNGSTEN ELECTRODE CONVERSION CHART

SIZE SUFFIX	INCHES	MILLIMETERS
20	.020"	.5mm
40	.040"	1.0mm
116	1/16"	1.6mm
332	3/32"	2.4mm
418	1/8"	3.2mm
532	5/32"	4.0mm
316	3/16"	4.8mm
14	1/4"	6.4mm

2C332 Size Suffix

2 SERIES GAS SAVER PARTS TORCH MODELS 9, 20

THREAD PATTERN: 5/16" x 24

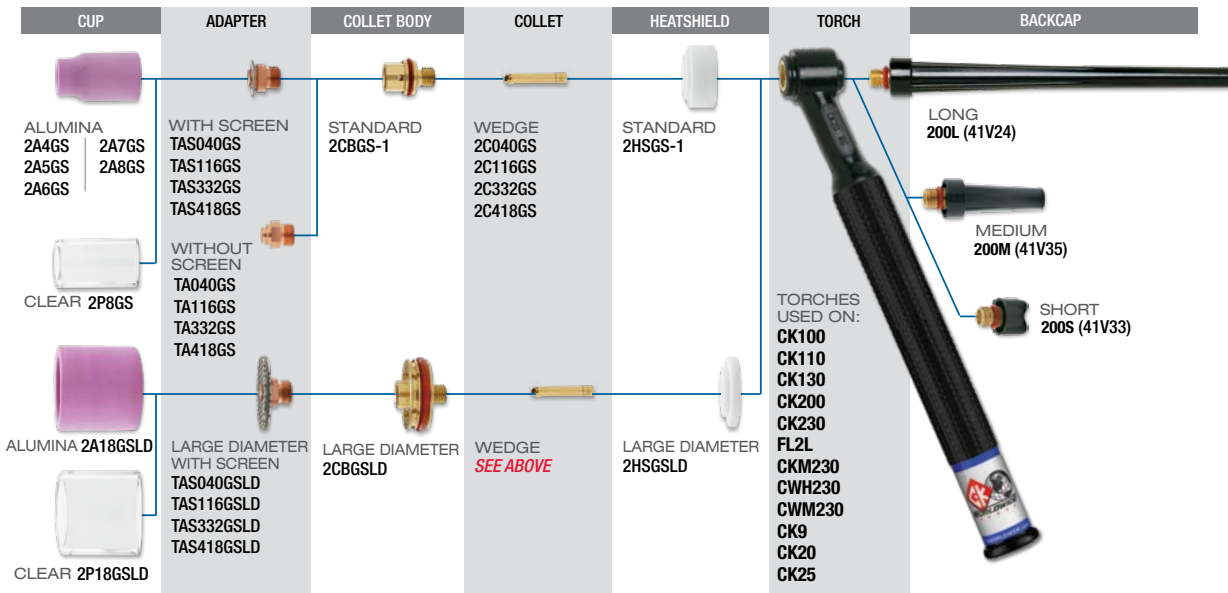

ACCESSORY KITS

Pre-packaged kits containing common consumables for our 2 Series torches.

2 SERIES | ORDER #AK-4



ITEM (Quantity 1 Each)	PART #
Long Backcap	200L (41V24)
1/16" (1.6mm) Collet	2C116 (13N22)
3/32" (2.4mm) Collet	2C332 (13N23)
1/8" (3.2mm) Collet	2C418 (13N24)
1/16" (1.6mm) Collet Body	2CB116 (13N27)
3/32" (2.4mm) Collet Body	2CB332 (13N28)
1/8" (3.2mm) Collet Body	2CB418 (13N29)
#5 (5/16" 8.0mm) Alumina Cup	2A5 (13N09)
#6 (3/8" 9.6mm) Alumina Cup	2A6 (13N10)
#8 (1/2" 12.8mm) Alumina Cup	2A8 (13N12)
1/16" (1.6mm) x 7" 2% Ceriated Tungsten	T1167GC2
3/32" (2.4mm) x 7" 2% Ceriated Tungsten	T3327GC2
1/8" (3.2mm) x 7" 2% Ceriated Tungsten	T187GC2

2 SERIES GAS SAVER | ORDER #AK-4GS

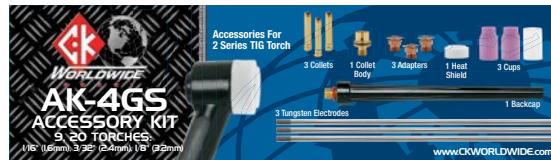

ITEM (Quantity 1 Each)	PART #
Long Backcap	200L (41V24)
1/16" (1.6mm) Collet	2C116GS
3/32" (2.4mm) Collet	2C332GS
1/8" (3.2mm) Collet	2C418GS
1/16" (1.6mm) Tungsten Adapter	TAS116GS
3/32" (2.4mm) Tungsten Adapter	TAS332GS
1/8" (3.2mm) Tungsten Adapter	TAS418GS
Collet Body	2CBGS-1
Heatshield	2HSGS-1
#4 (1/4" 6.4mm) Alumina Cup	2A4GS
#6 (3/8" 9.6mm) Alumina Cup	2A6GS
#8 (1/2" 12.8mm) Pryex Cup	2P8GS
1/16" (1.6mm) x 7" 2% Ceriated Tungsten	T1167GC2
3/32" (2.4mm) x 7" 2% Ceriated Tungsten	T3327GC2
1/8" (3.2mm) x 7" 2% Ceriated Tungsten	T187GC2

2 SERIES | ORDER #AK-1 (NOT SHOWN)
 .040" (1.0mm) 1/16" (1.6mm) accessory kit. See website for details.

TROUBLESHOOTING GUIDE

PROBLEM	CAUSE	SOLUTION
Excessive Electrode Consumption	Inadequate gas flow	Increase gas flow
	Improper size electrode for current required	Use larger electrode
	Operating of reverse polarity	Use larger electrode or change polarity
	Electrode contamination	Remove contaminated portion, then prepare again
	Excessive heating inside torch	Replace collect, try wedge collet or reverse collet
	Electrode oxidizing during cooling	Increase gas post flow time to 1 sec. per 10 amps
	Shield gas incorrect	Change to proper gas (no oxygen or Co2)
Erratic Arc	Incorrect voltage (arc too long)	Maintain short arc length
	Current too low for electrode size	Use smaller electrode or increase current
	Electrode contaminated	Remove contaminated portion, then prepare again
	Joint too narrow	Open joint groove
	Contaminated shield gas, dark stains on the electrode or weld bead indicate contamination	Most common cause is moisture or aspirated air in gas stream. Use welding grade gas only. Find the source of the contamination and eliminate it promptly.
	Base metal is oxidized, dirty or oily	Use appropriate chemical cleaners, wire brush or abrasives prior to welding.
Inclusion of Tungsten or Oxides in Weld	Poor scratch starting technique	Many codes do not allow scratch starts. Use copper strike plate. Use high-frequency arc starter.
	Excessive current for tungsten size used	Reduce current or use larger electrode
	Accidental contact of electrode with puddle	Maintain proper arc length
	Accidental contact of electrode to filler rod	Maintain a distance between electrode and filler metal
	Using excessive electrode extension	Reduce electrode extension to recommended limits
	Inadequate shielding or excessive drafts	Increase gas flow, shield arc from wind, or use gas lens
	Wrong gas	Do not use Ar-O2 or Ar-Co2 GMA (MIG) gases for TIG welding
Heavy surface oxides not being removed	Use ACHF, adjust balance control for maximum cleaning, or wire brush and clean the weld joint prior to welding.	
Porosity in Weld Deposit	Entrapped impurities, hydrogen, air, nitrogen, water vapor	Do not weld on wet material. Remove condensation from line
	Defective gas hose or loose connection	Check hoses and connections for leaks
	Filler material is damp (particularly aluminum)	Dry filler metal in oven prior to welding
	Filler material is oily or dusty	Replace filler metal
	Alloy impurities in the base metal such as sulphur, phosphorus, lead and zinc	Change to a different alloy composition which is weldable. These impurities can cause a tendency to crack when hot.
	Excessive travel speed with rapid freezing of weld trapping gases before they escape	Lower the travel speed
Contaminated gas shield	Replace the shielding gas	
Cracking in Welds	Hot cracking in heavy section or with metals which are hot shorts	Preheat, increase weld bead cross-section size, change weld bead contour.
	Crater cracks due to improperly breaking the arc or terminating the weld at the joint edge	Reverse direction and weld back into previous weld at edge. Use remote or foot control to manually down slope current.
	Post weld cold cracking, due to excessive joint restraint, rapid cooling, or hydrogen embrittlement	Preheat prior to welding, use pure to non-contaminated gas. Increase the bead size. Prevent craters or notches. Change the weld joint design.
	Centerline cracks in single pass welds	Increase bead size. Decrease root opening, use preheat, prevent craters.
Underbead cracking from brittle microstructure	Eliminate sources of hydrogen, joint restraint, and use preheat.	
Inadequate Shielding	Gas flow blockage or leak in hoses or torch	Locate and eliminate blockage or leak.
	Excessive travel speed exposes molten weld to atmospheric contamination	Use slower travel speed or carefully increase the flow rate to a safe level below creating excessive turbulence. Use trailing shield cup.
	Wind or drafts	Set up screens around the weld area
	Excessive electrode stickout	Reduce electrode stickout. Use a larger size cup.
Excessive turbulence in gas stream	Change to gas saver parts or gas lens parts.	
Arc Blow	Induced magnetic field from DC weld current	Change to ACHF current. Rearrange the split ground connection.
	Arc is unstable due to magnetic influences	Reduce weld current and use arc length as short as possible.
Short Parts Life	Short water cooled leads life	Verify coolant flow direction, return flow must be on the power cable lead.
	Cup shattering or breaking in use	Change cup size or type, change tungsten position, refer to CK Worldwide technical specifications available at www.CKWORLDWIDE.com
	Short collet life	Ordinary style is split and twists or jams, change to wedge style.
	Short torch head life	Do not operate beyond rated capacity, use water cooled model, do not bend rigid torches.
	Gas hoses ballooning, bursting or blowing off while hot	Incorrect flowmeter, TIG flowmeters operate at 35 psi with low flows. MIG flowmeters operate with high flows at 65 psi or more.

© 2017/2019 CK Worldwide, Inc. All rights reserved. 2367 Printed 4/2019



Phone: 1.800.426.0877 Fax: 1.800.327.5038
 CK Worldwide, Inc., PO Box 1636, Auburn, WA 98071

CONNECT WITH US ON:



www.CKWORLDWIDE.com

TRADEMARK NOTICES: Gas Saver™, Safe-Loc™, Flex-Loc™, Super-Flex™, Trim-Line™, Max-Flo™, Fail-Safe™, Steady-Grip™ and LaYzr™ are registered trademarks of CK Worldwide, Inc.