

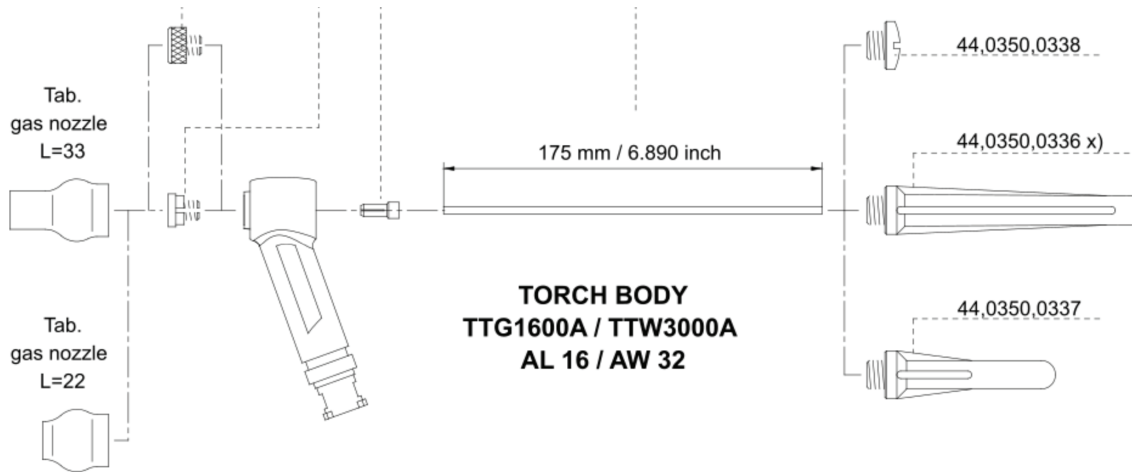

CONSUMABLES FOR FRONIUS TIG TORCHES

TTG1200A TTG1600A TTW2500A TTW3000A



PICTURE	PART NUMBER	SHORT DESCRIPTION	QTY REQUIRED
	44,0350,0336	Torch Cap Long	1
	44,0350,0337	Torch Cap Middle	1
	44,0350,0338	Torch Cap Short	1
	42,0001,1148	.040" (1.0) Clamping Sleeve	1
	42,0001,1149	1/16" (1.6) Clamping Sleeve	1
	42,0001,1150	3/32" (2.4) Clamping Sleeve	1
	42,0001,1151	1/8" (3.2) Clamping Sleeve	1
	42,0001,0692	.040" Clamping Nut	1
	42,0001,0693	1/16" Clamping Nut	1
	42,0001,0693	3/32" Clamping Nut	1
	42,0001,0695	1/8" Clamping Nut	1



CONSUMABLES FOR FRONIUS TIG TORCHES TTG1200A TTG1600A TTW2500A TTW3000A

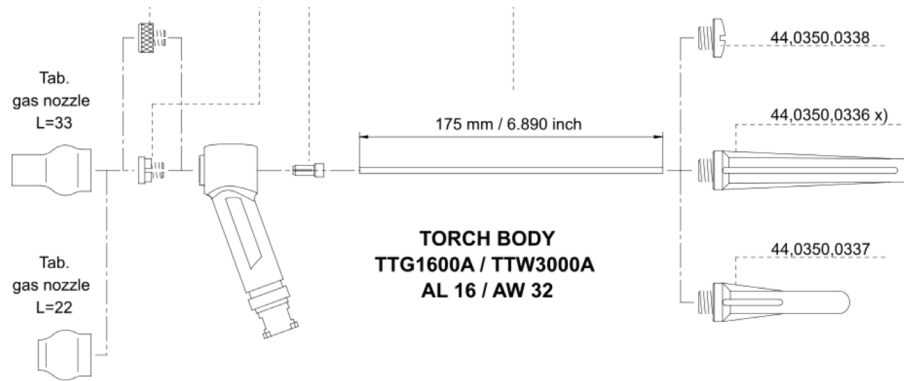

	44,0350,1500	.040" Gas Lens OPTIONAL	1
	44,0350,1501	1/16" Gas Lens OPTIONAL	1
	44,0350,1460	3/32" Gas Lens OPTIONAL	1
	44,0350,1461	1/8" Gas Lens OPTIONAL	1
	42,0300,0816	No. 4 Ceramic Nozzle .866 (22mm) Long	1
	42,0300,0817	No. 5 Ceramic Nozzle .866 (22mm) Long	1
	42,0300,0818	No. 6 Ceramic Nozzle .866 (22mm) Long	1
	42,0300,0819	No. 7 Ceramic Nozzle .866 (22mm) Long	1
	42,0300,0820	No. 4 Ceramic Nozzle 1.299 (33mm) Long	1
	42,0300,0821	No. 5 Ceramic Nozzle 1.299 (33mm) Long	1
	42,0300,0822	No. 6 Ceramic Nozzle 1.299 (33mm) Long	1
	42,0300,0823	No. 7 Ceramic Nozzle 1.299 (33mm) Long	1
	42,0201,2368	Torch Cap Key	1